



ATEX Zone 1 II B + H2 T6

CSA/CUS Class 1 Div 1 Group B, C + D



Process Analyzer **User Manual**

P-500 FLASH POINT ANALYZER



FOREWORD

FOREWORD

Table of Contents	i
Warranty	v

INTRODUCTION - SECTION 1

Analyzer Overview	1-1
Principle of Operation.....	1-1
Component Identification	1-3
Front View.....	1-3
Electronics Enclosure	1-4
Measurement Enclosure.....	1-5
Menu Structure.....	1-6
Description of Markings.....	1-8
Explanation of Marking Details	1-8
Storage.....	1-9
Inspection.....	1-9

SPECIFICATIONS - SECTION 2

Models.....	2-1
Performance.....	2-1
Sample Requirements.....	2-1
Signal Inputs/Outputs.....	2-2
Utility Requirements	2-2
Analyzer Enclosure	2-2
Available Options and Accessories.....	2-2

INSTALLATION AND STARTUP - SECTION 3

Site Requirements.....	3-1
Location	3-1
Mounting.....	3-1
Piping	3-3
Process Sample Lines.....	3-3
Combustion Air Supply	3-3
Atmospheric Drain.....	3-3
Wiring	3-3
Electrical Power.....	3-4
Control Room Signals.....	3-5
Analog Output	3-5
Relay Output	3-5
Serial Output	3-5
Modbus over IP	3-5
Dry Contacts	3-5
Startup.....	3-7
Box Heater Adjustment	3-8
Basic Operation.....	3-8

PROGRAMMING – SECTION 4

Main Run Screen 4-1

Menu Navigation 4-1

 Advance Screen Key 4-2

 Index Key 4-2

 Enter Key 4-2

 Up/Down Arrow Keys 4-2

Main Menu..... 4-2

 Analyzer Status..... 4-2

 Alarm History 4-2

 Service..... 4-2

 Setup 4-3

Setup Sub-Menu 4-3

 Output Settings..... 4-4

 4-20 Out 1 / 4-20 Out 2 4-4

 Digital Output 4-4

 Flash Point Graph 4-5

 Sample Temperature Graph 4-5

 Alarm Settings 4-5

 Flash Point Alarms 4-5

 Sample Temperature Alarms 4-6

 System Settings..... 4-6

 System Settings 4-6

 Temperature Unit..... 4-6

 Standby Mode 4-6

 Number Cycles 4-7

 Cycle Limit 4-7

 Come Read..... 4-7

 Reload Defaults 4-7

 Digital Inputs 4-7

 Customer Alarm..... 4-7

 Remote Standby..... 4-7

 Screen Settings..... 4-7

 Intensity 4-7

 Screen Saver 4-7

 Detect Control 4-7

 Frequency..... 4-7

 Spark on 4-7

 Spark Off..... 4-7

 Delta Temperature..... 4-7

 Detect Level..... 4-7

 Sample Heat Control..... 4-8

 Initial Heat..... 4-8

 Heat Step..... 4-8

 Incremental Heat 4-8

 Decremental Heat..... 4-8



Cool Mode 4-8

Relay 4-8

 Relay..... 4-8

 Type..... 4-8

 Sense..... 4-8

Time/Date Setup..... 4-9

State Table 4-10

Factory Setup 4-10

NORMAL OPERATION – SECTION 5

Main Run Screen 5-1

 Measurement Results..... 5-1

 Date & Time..... 5-1

 Graphical Data Display..... 5-2

 Operational Status..... 5-2

 Message Line 5-2

Signal Outputs..... 5-2

 4-20 mA Analog Output..... 5-2

 Serial Output..... 5-2

 Modbus over IP Output..... 5-2

Alarms 5-3

 Types of Alarm Conditions 5-3

 Alarm Warning 5-3

 Alarm Critical..... 5-3

 Come Read 5-3

 Maintenance..... 5-3

 Informational Messages 5-3

Alarm History..... 5-4

Taking the Analyzer Off-Line..... 5-5

 Locally..... 5-5

 Remotely..... 5-5

Loss of Power Restart..... 5-6

Internal Sample Lead..... 5-6



ROUTINE MAINTENANCE & SERVICE – SECTION 6

Recommended Routine Maintenance Schedule 6-1

Taking the Analyzer Down for Service..... 6-1

Service & Operational Checks 6-2

 Mechanical..... 6-2

 Air Purge 6-2

 Validation 6-2

 Stream Select..... 6-2

 Spark..... 6-2

 Detector 6-2

 Detect Level 6-2

 Detect Latch 6-2

 Clear Latch..... 6-2

 Sample..... 6-2

 Temperature..... 6-2

 Heat..... 6-3

 Power 6-3

 4-20 Outputs 6-3

 4-20 mA Out 1 6-3

 5-20 mA Out 2..... 6-3

 Alarms..... 6-3

 Digital Inputs 6-3

Troubleshooting 6-3

Component Cleaning & Replacement..... 6-4

 Flash Cup 6-4

 Air Purge Tube..... 6-4

 Spark Electrode 6-4

Assembly Drawings..... 6-5

 Flash Cup 6-5

 Measurement Enclosure..... 6-6

 Control Enclosure 6-7

 Control Enclosure Door 6-8

SPARE & REPLACEMENT PARTS – SECTION 7

1-Year Spare Parts Kit 7-1

2-Year Spare Parts Kit 7-1

Replacement Parts..... 7-1



WARRANTY

POLICY

Orb Instruments warrants its products to the original purchaser against any defects that are due to faulty material or workmanship for a period of one year from date of shipment unless otherwise noted in the product manual.

In the event that a defect is discovered during the warranty period, Orb Instruments agrees that, at its option, it will repair or replace the defective product or refund the purchase price, excluding original shipping and handling charges. Any product repaired or replaced under this warranty will be warranted only for the remainder of the original product warranty period.

This warranty does not apply to consumable products such as chemical reagents, or consumable components of a product, such as, but not limited to, lamps and tubing.

Contact ORB Instruments or your distributor to initiate warranty support. Products may not be returned without authorization from ORB Instruments.

LIMITATIONS

This warranty does not cover:

- Damage caused by acts of God, natural disaster, labor unrest, acts of war (declared or undeclared), terrorism, civil strife or acts of any governmental jurisdiction.
- Damage caused by misuse, neglect, accident or improper application or installation.
- Any product not used in accordance with the instructions furnished by ORB Instruments.
- Freight charges to return merchandise to ORB Instruments.
- Freight charges on expedited or express shipment of warranted parts or product.
- Travel fees associated with on-site warranty repair.

This warranty contains the sole express warranty made by ORB Instruments in connection with its products. All implied warranties, including without limitation, the warranties of merchantability and fitness for a particular purpose, are expressly disclaimed.

Some states within the United States do not allow the disclaimer of implied warranties and if this is true in your state, the above limitations may not apply to you. This warranty gives you specific rights, and you may also have other rights that vary from state to state.

This warranty constitutes the final, complete, and exclusive statement of warranty/terms and no person is authorized to make any other warranties or representations on behalf of ORB Instruments.

LIMITATION OF REMEDIES

The remedies of repair, replacement or refund of purchase price as stated above are the exclusive remedies for the breach of this warranty. On the basis of strict liability or under any other legal theory, in no event shall ORB Instruments be liable for any incidental or consequential damages of any kind for breach of warranty or negligence.

ANALYZER OVERVIEW

The ORB Instruments' Model P-500 Flash Point Analyzer is an on-line instrument designed to continuously measure the flash point of mid-distillate products. Extremely rugged and simple to operate, the compact P-500 Flash Point Analyzer combines exceptional measurement accuracy with unmatched operational dependability to deliver highly reliable and repeatable flash point determinations day in, day out, month after month.

- Superior repeatability — $\pm 1.0^{\circ}\text{C}$ (2.0°F) or better.
- Rapid analytical cycle — Typically 5 minutes or less.

For optimum installation and applications versatility, the P-500 Flash Point Analyzer incorporates a wide variety of standard features, including:

- Isolated 4-20 mA analog output; optional second output available.
- Serial output.
- Three SPDT dry contact alarm relays.
- Optional ModBus over IP output.
- Separate electronics and measurement enclosures.
- Optional sample conditioning and high pressure sample delivery/return systems available.
- Optional high pressure sample recovery system available.
- NEC Class 1, Division 1, Group C, D or European ATEX Zone 1, Group II B + H2 T4 hazardous area classification.

PRINCIPLE OF OPERATION

The P-500 Flash Point Analyzer is designed to provide flash point measurements in correlation with ASTM Methods D-56 (Tag) and D-93 (Pensky-Martens Closed Cup). It incorporates a highly reliable, yet sophisticated flash detection system consisting of a small, stainless steel flash chamber, sample mixing and heating tube, spark ignition circuitry, and pressure detection system (used for flash detection).

A typical measurement cycle proceeds as follows:

1. Sample and combustion air are mixed (air line integrity protected via a check valve) and then flow into the sample mixing/heating tube (MHT) within the measurement enclosure. This specially designed component facilitates uniform mixing and controlled heating of the continually flowing sample.
2. The air/sample mixtures leaves the MHT and enters the stainless steel flash chamber where it separates into liquid and flammable vapors.
3. A spark ignition source is applied at a controlled rate to the vapors within the flash chamber; a detection circuit (based on pressure wave detection from sample ignition) continuously monitors for actual flash. When flash is detected, the incoming sample temperature is recorded and reported.
4. The sample heater is then turned off and the sample allowed to cool for a specific time or to a specific temperature below the reported flash point temperature. The temperature setpoint of the stainless steel flash chamber is then set to the last detected flash point temperature. This control of the flash chamber temperature minimizes the offset to the actual lab method.

By continuously tracking analyzer conditions during the analysis cycle, internal diagnostics are able to quickly detect abnormal events.

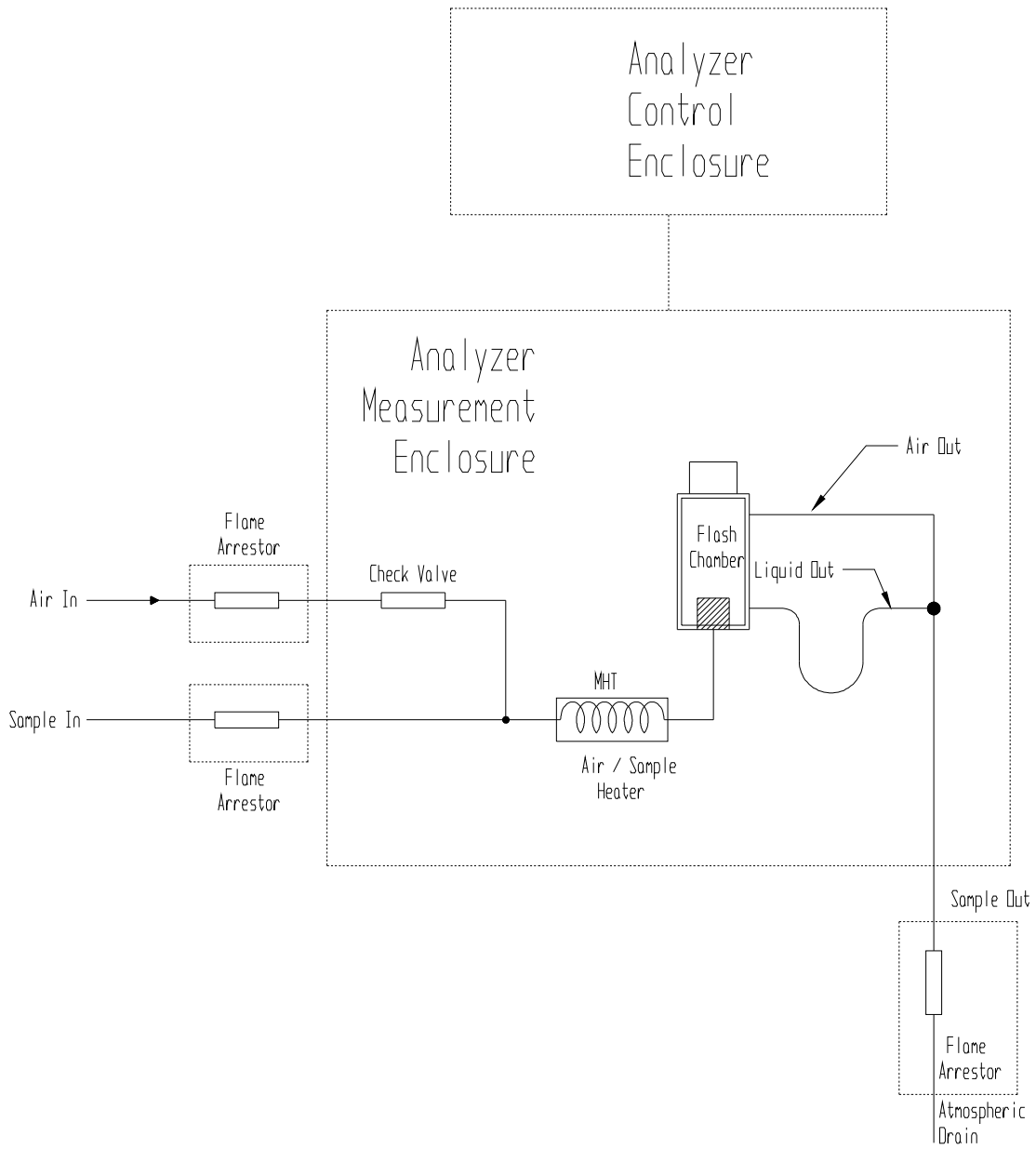

Figure 1-1: Flow Schematic

COMPONENT IDENTIFICATION

FRONT VIEW

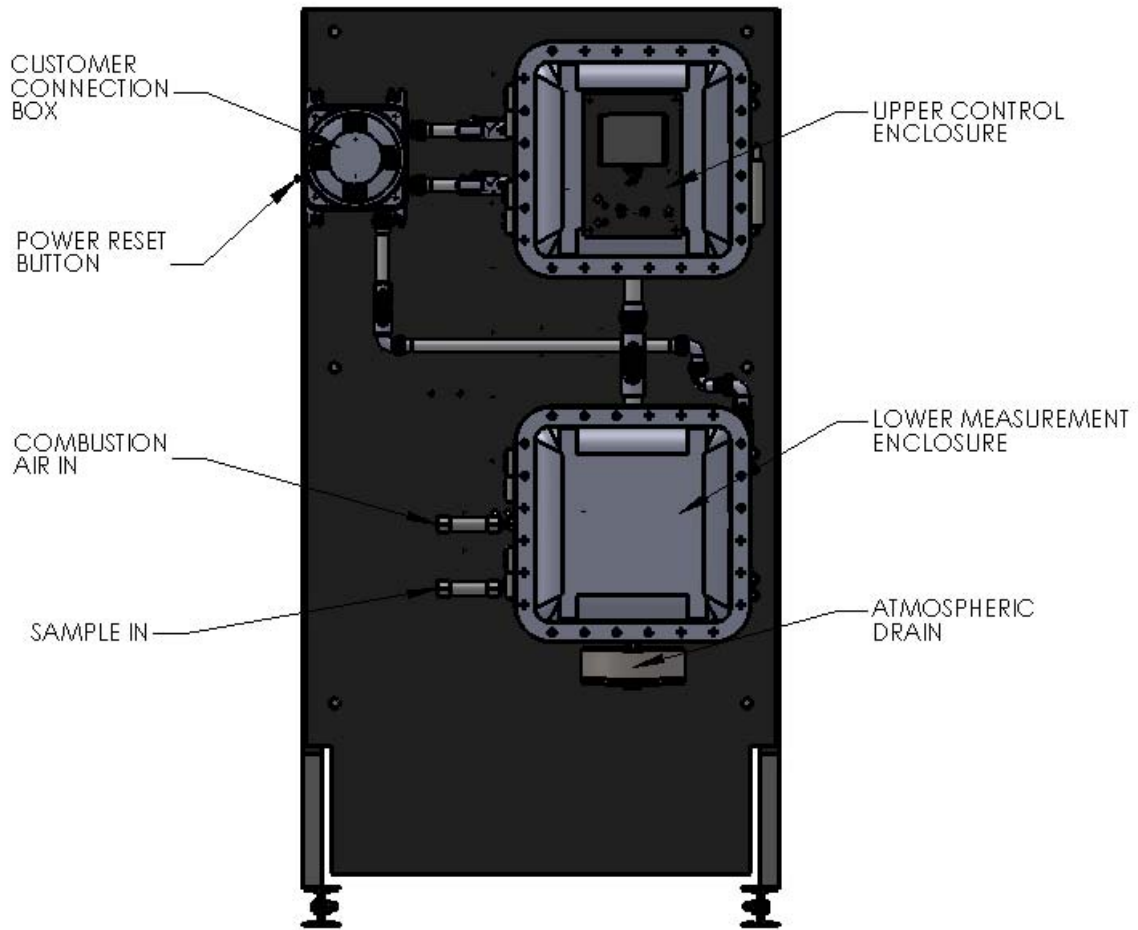

Figure 1-2: Front View

ELECTRONICS ENCLOSURE

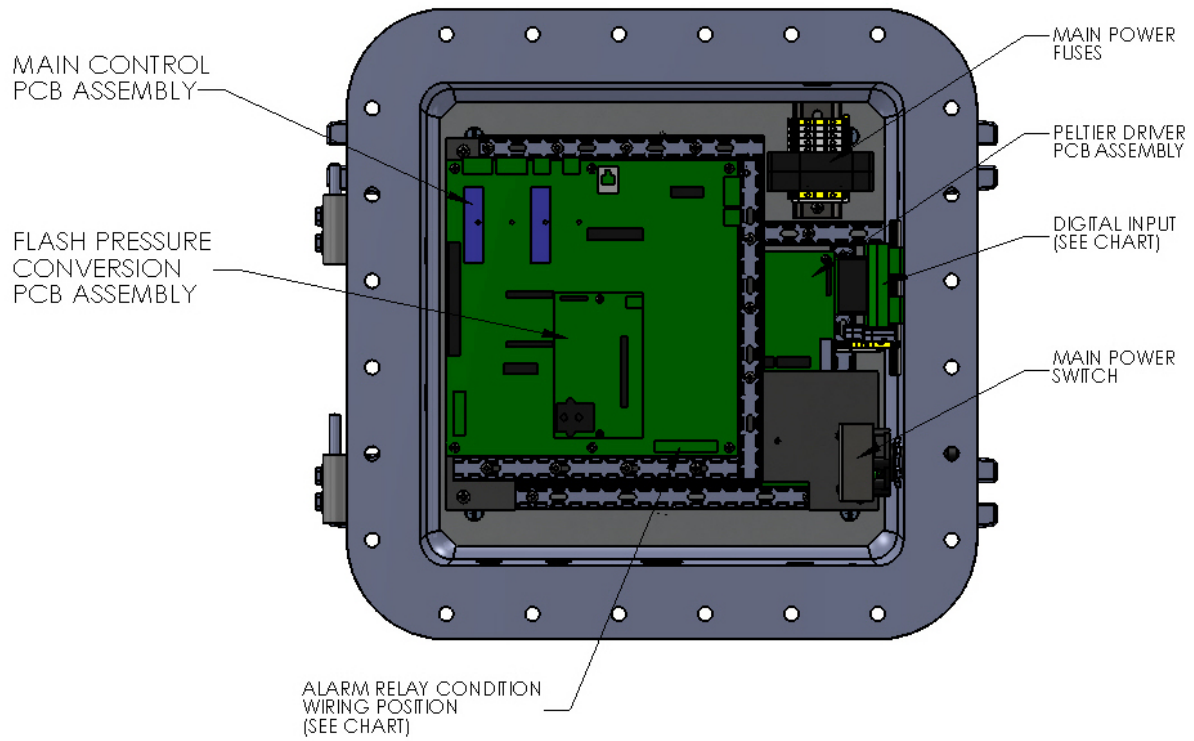

Figure 1-3: Electronics Enclosure

MEASUREMENT ENCLOSURE

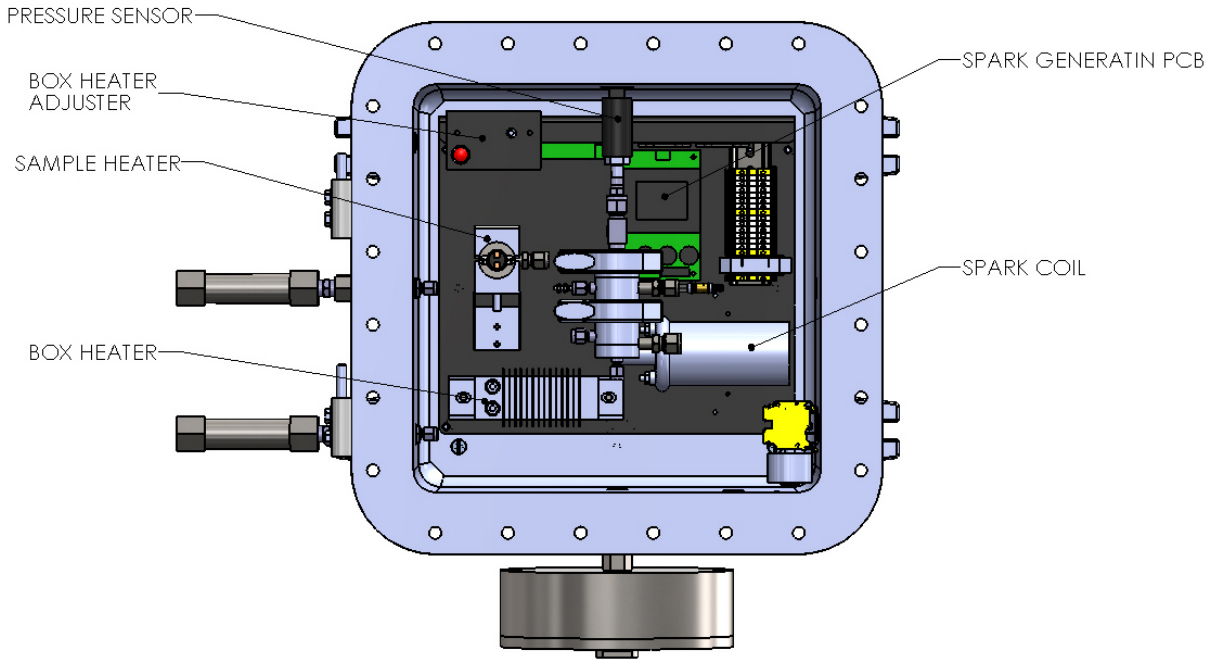

Figure 1-4: Measurement Enclosure

MENU STRUCTURE

Main Menu	Sub-Menu	Items	Choices / Settings / Comments
Analyzer Status	—	—	Online/Offline
Alarm History	—	—	Display only
Service	—	Mechanical Air Purge Validation Stream Select Spark Detector Detect Level Detect Latch Clear Latch Sample Temperature Heat Power 4-20mA Outputs Output 1 Output 2 Alarms R1 R2 R3 Digital Inputs Cust Alarm Rem Standby Validation Smpl Overtmp	Tests air purge operation (ON/OFF) Tests validation operation (ON/OFF) Tests stream select operation (ON/OFF) Tests spark operation (ON/OFF) 0 to 999 Display only (latch status) Manual latch release Display only Tests sample heater Increases/decreases heater power Used to calibrate external devices Used to calibrate external devices Tests alarm relay 1 Tests alarm relay 2 Test alarm relay 3 Tests customer alarm input Tests remote standby input Tests validation input Display only

Main Menu	Sub-Menu	Items	Choices / Settings / Comments
Setup	Output Settings	4-20 Out 1	Flash Point / Sample Temperature / Disable 4 mA value / 20 mA value / offset
		4-20 Out 2	Flash Point / Sample Temperature / Disable 4 mA value / 20 mA value / offset
		Digital Output	RS232R / RS232D / None / ModBus IP
		Flash Point Graph	Enable / Disable Low and high values; clear graph
	Alarm Settings	Flash Point	Low and High alarm settings
		Sample Temperature	Low and High alarm settings
	System Settings	System Settings	System Settings
Temp Units			°C / °F
Standby Mode			On / Off
Num Cycles			Number of measurements run since reset
Cycle Limit			Maintenance reminder
Come Read			Length of time relay will be activated
Reload Defaults			Restores analyzer's factory defaults
Digital Inputs			
Cust Alarm			Enable / Disable
Rem Stdby			Enable / Disable
Screen Settings	Intensity	Screen brightness adjustment	
	Screensaver	Time display will remain lit without keypad activity	
Detect Control	Frequency	Spark generation frequency (50 / 60 / 100 / 120 Hz)	
	Spark On	Length of time spark will be applied	
	Spark Off	Length of time spark will be off	
	Delta Temp	Difference (in degrees) from last flash point detection required to initiate spark	
Detect Level	0 to 999		
Sample Heat Control	Init Heat	Heater power (%)	
	Heat Step	Sets increase in heater power (%)	
	Inc Heat	Sets time parameter for increasing heat (seconds)	
	Dec Heat	Sets time parameter for decreasing heat (seconds)	
	Cool Mode	Cooling parameter (Off / Decrement)	
Relay	Relay number (1 / 2 / 3) Type (Critical Alarm / Warning Alarm / Maintenance / Come Read / Off) Sense (Normal / Failsafe)		
State Table	—	Steps in measurement cycle	
Time/Date Setup	—	Time Format (12 or 24 hour) / Date Format (US or EU) / Date / Time	
Factory Setup	—	For factory use only	

DESCRIPTION OF MARKINGS



Figure 1-5: System Markings

EXPLANATION OF MARKING DETAILS

Note 1: The ORB Instruments, Inc. company logo.

Note 2: General system warnings. The first and second sentences warn the user not to open the enclosures unless de-energized and/or the area has been de-rated by appropriate safety authorities. Sentence three defines the minimum yield stress for the enclosure cover bolts. Sentence four references this manual for specific installation instructions.

Note 3: The specific mark for explosion protection followed by: II ("Roman Numeral 2") which defines the equipment group (Group II = Equipment For Use in Explosive Atmospheres Other Than Mining), 2 (the number "2") which defines the equipment category (Category 2 = Equipment For Use in Zone 1 Classified Areas), and G (the letter "G") which defines the suitability of use of Group II equipment (G = gas atmospheres).

Note 4: Company name and physical address make up the first three lines. The fourth line is the product model number. The fifth line is the parameter the analyzer is measuring. The sixth line is the customer specific serial number. The seventh line is the month and year of equipment manufacture. The eighth line is the electrical ratings of the system.

Note 5: Line one is the associated ATEX certificate file number for the equipment. Line two is the products hazardous area classification. "Ex d" defines a flameproof explosion protection concept ("flameproof" is defined as ignition within the apparatus enclosure is contained and will not ignite surrounding explosive atmospheres). "IIB + H2" defines the gas grouping (IIB + H2 defines the typical gas hazards as ethylene and hydrogen). "T6" defines the temperature class of the instrument (T6 defines no surface temperature greater than 85°C). "Gb" defines equipment for explosive gas atmospheres, having a "high" level of protection, which is not a source of ignition in normal operation or during expected malfunctions. The third line defines the ambient temperature range. The fourth line defines the maximum process temperature.

Note 6: The "CE" mark denotes ORB's declaration of product compliance to all relevant EU directives. The four digits "0518" is the number of the notified body responsible for EC monitoring of production quality.

STORAGE

Should the unit have to be stored for a prolonged period of time before installation, the following factors should be taken into consideration to avoid product damage:

- Unit should be stored in its original shipping crate and VCI wrap.
- Crate should be stored in its original upright and vertical position with arrows pointing up.
- Crate should not be stacked or stacked upon.
- Crate should not be exposed to adverse weather conditions (wind, rain, sand) for prolonged periods.
- Crate should not be subject to intense vibration.
- Ambient storage temperature should remain between -20°C and 50°C (-4°F and 122°F)

INSPECTION

Before preparing the instrument for installation, a visual inspection should be made of the shipping crate to ensure no damage that could compromise safety has occurred to the unit. Any instance of damage noticed should be documented and reported to the shipment's carrier. Failure to document this damage adequately could result in the carrier's refusal to process a damage claim.

Of the shipping crate: Should any of the following factors be noticed of the shipping crate or VCI wrap during inspection the unit should not be installed until a more detailed inspection by a factory authorized representative can be made.

- Scorch marks or evidence of extreme heat.
- Cracked, crushed, or missing crate panels.
- Any signs of tampering or intentional neglect.



03-27-2014

[THIS PAGE INTENTIONALLY BLANK]



MODELS

P-500-1400	For NEC Class I, Division 1, Group C and D areas.
P-500-1500	For ATEX Zone I, II B + H2 T4 areas.

PERFORMANCE

Measurement Range	25° to 125°C (77° to 257°F) selectable; lower ranges available (consult Orb Instruments).
Repeatability	±1.0°C (2.0°F)
Reproducibility	±1.0°C (2.0°F)
Resolution (temperature sensor)	±0.01°C (0.02°F)
Measurement Accuracy	Correlates to ASTM Methods D56 (Tag) and D-93 (Pensky-Martens Closed Cup).
Temperature Accuracy	±0.1 °C (±0.2°F)
Measurement Cycle Time	5 minutes or less
Operating Temperature Range	Minimum: 5°C (40°F) Maximum: 40°C (105°F)
Ambient Temperature Rating	Minimum: -20°C (-4°F) Maximum: 40°C (105°F)

SAMPLE REQUIREMENTS

Sample Flow Rate	Minimum: 10 cc/minute Maximum: 50 cc/minute
Sample Return Pressure	Atmospheric; optional high pressure sample conditioning system available.
Sample Pressure	Minimum: 1.4 bar (20 psi) Maximum: 10.0 bar (150 psi)
Sample Temperature	At least 5°C (9°F) below expected flash point; No more than 35°C (63°F) below expected flash point; Maximum process temperature of 100°C (212°F); Optional sample cooling available (consult Orb Instruments).
Sample Particulates	Less than 10 µm; optional sample conditioning system available.
Sample Conditions	Homogeneous, single-phase sample. Must be free of water or water moisture.



SIGNAL INPUTS/OUTPUTS

Analog Output	One isolated 4-20 mA output standard; Optional second isolated 4-20 mA output available. The information for both analog outputs is programmable.
Serial Communication	RS232
Relay Output	Three SPDT failsafe relay contacts rated at 3A resistive load at 250 VAC. May be programmed for normal or failsafe operation. The conditions activating these relays are programmable.
ModBus	Optional; consult ORB Instruments.

UTILITY REQUIREMENTS

Power	Single phase; 100 to 240 VAC, 50/60 Hz.
Combustion Air Supply	Clean, dry instrument air controlled at 100 to 500 cc/minute at approximately 0.7 to 1.4 bar (10-20 PSI)

ANALYZER ENCLOSURE

Dimensions (W x H x D)	Overall: 955 x 1854x 762 mm (38.0 x 73.0 x 30.0 inches) Control & Measurement: 356 x 356 x 203 mm (14 x 14 x 8 inches) Customer Connection: 171 x 171 76 mm (6.75 x 6.75 x 3 inches)
Weight	Overall: Approximately 227 kg (500 pounds) Control & Measurement: Approximately 73 kg (160 pounds) Customer Connection: Approximately 9 kg (19 pounds)
Enclosure Rating / Material	Explosion-proof cast aluminum copper free alloy (maximum copper content 0.3%).
Hazardous Classification	Model dependent; see above.

AVAILABLE OPTIONS AND ACCESSORIES

High Pressure Sample Recovery System (p/n 700228)	For sample return pressures greater than 2.4 bar (35 PSI); 8.3 bar (120 PSI) maximum.
High Pressure Sample Delivery and Return System (p/n 700566)	Sample pressure reduction, flow metering, and high pressure sample return system.
Sample Conditioning Panel (p/n 700538)	Application specific. Customizable for free water, emulsified water, heavy and light particulates, below atmospheric sampling, environmental concerns, and sample temperature conditioning.

Due to ORB Instruments' commitment to continual product improvement, specifications subject to change without notice.

	<p>WARNING: Installation or operation of this Analyzer outside of the parameters indicated in the Specifications could result in personal injury or damage to the Analyzer. Installation, operation, and maintenance should be performed only by fully qualified personnel.</p>
---	--

SITE REQUIREMENTS

Your particular site, application, and installed options will ultimately determine the need for any accessories or auxiliary equipment. This section defines the various parameters to be considered. Consult ORB Instruments for specific recommendations regarding your P-500 Flash Point Analyzer.

LOCATION

For ease of operation, your Analyzer should be installed as close as possible to the process stream to be monitored. To optimize performance, it should be housed in an appropriate shelter and protected against direct sunlight, moisture, and other adverse conditions. The shelter's ambient temperature should remain between -20° and 40°C (-4° and 105°F) at all times.

MOUNTING

The P-500 Flash Point Analyzer is mounted on a free-standing rack or (optional) equipped with brackets for wall mounting. It should be located on a flat surface and isolated from intense vibration. Adequate clearance (approximately 30.5 cm/12 inches) should also be allowed on either side of the unit for sample, utility, and control room connections.

See Figure 3-1

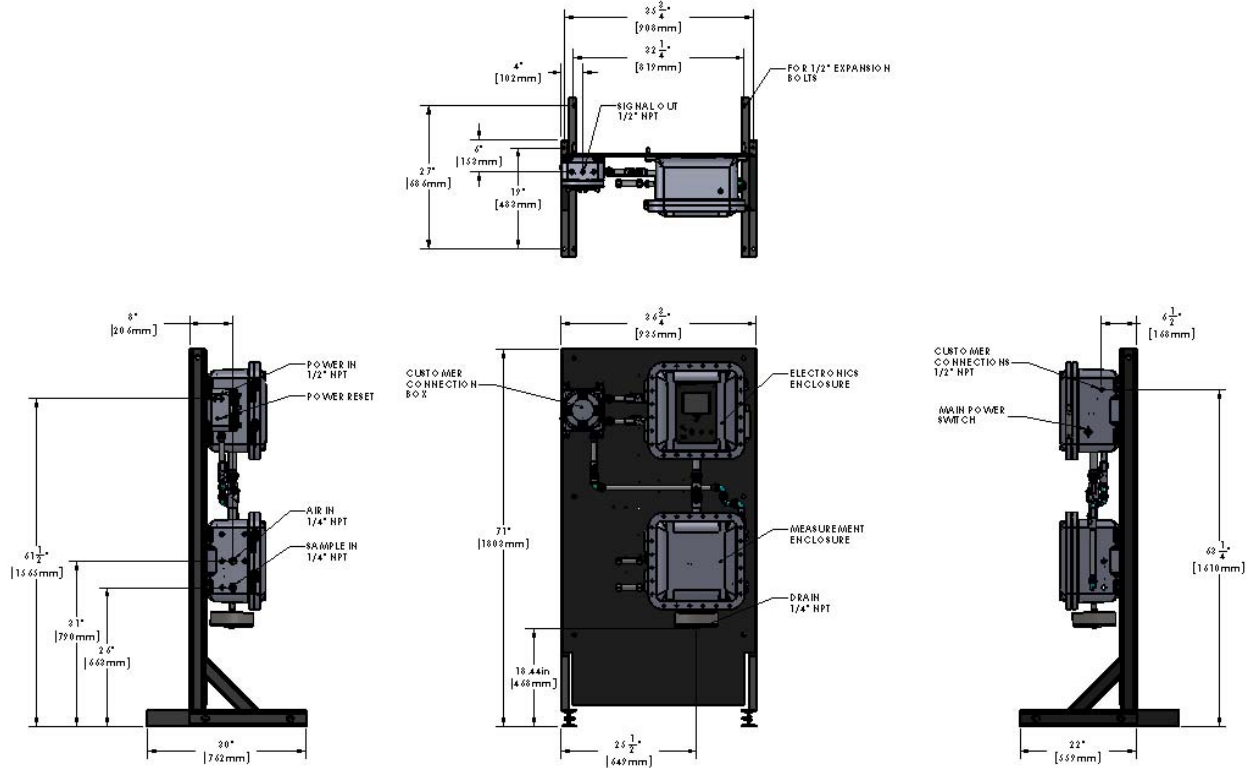

Figure 3-1: Dimensional Drawing

PIPING

The P-500 Flash Point Analyzer incorporates fittings for connecting process sample and combustion air lines. These fittings are located on the left side of the instrument.

See Figure 3-2.

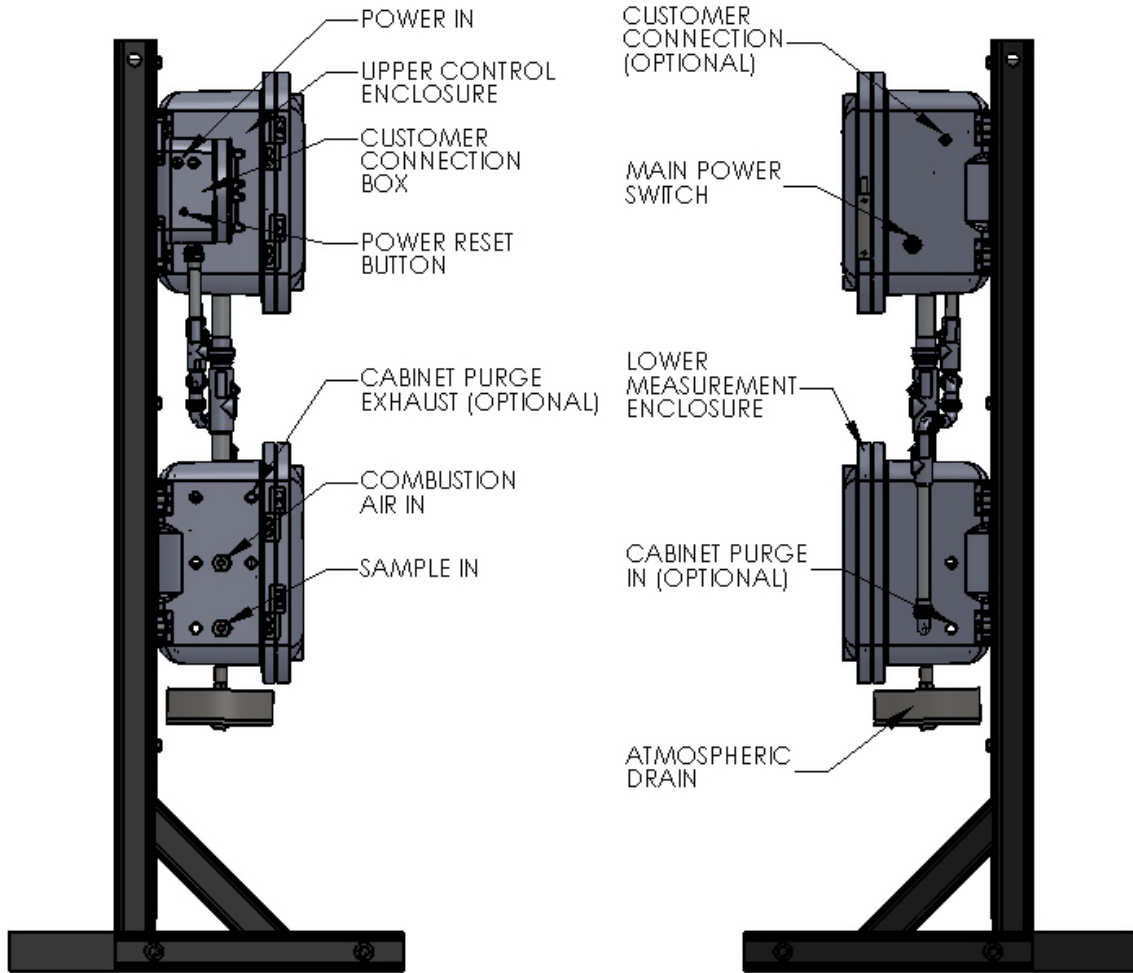



Figure 3-2: Left and Right Side Views

PROCESS SAMPLE LINES

	<p>NOTE: It is the user's responsibility to assure that a representative sample, free of moisture and particulate matter, is presented to the instrument for analysis. ORB Instruments can assist in specifying sample conditioning requirements and the selection/development of an appropriate sample conditioning system.</p>
---	---

The P-500's sample inlet is located on the left side of the analyzer's measurement enclosure. This line should be connected to the 1/4 inch NPT fitting labeled "Sample In" (see Figure 3-2). Process samples should be provided at a pressure between 1.4 and 10 bar (20 and 150 psi) at a flow rate of 10 to 50 cc/minute. The temperature of the sample should be at least 5°C (9°F) below the expected flash point temperature and no more than 35°C (63°F) below the expected flash point temperature while remaining under the maximum process temperature of 100°C (212°F).

COMBUSTION AIR SUPPLY

Clean, dry instrument air is required for proper analyzer operation. It should be supplied to the analyzer at a controlled flow rate between 100 and 500 cc/minute. The instrument air line is connected to the 1/4 inch NPT fitting labeled "Combustion Air" on the left side of the measurement enclosure (see Figure 3-2).

ATMOSPHERIC DRAIN

The Measurement enclosure incorporates an atmospheric drain that should be piped to a collection vessel for the recovery of spent sample. This drain is located at the bottom of the right of the measurement enclosure. Figure 3-2.

	<p>WARNING: It is the user's responsibility to install an appropriate flame arrestor on the atmospheric drain outlet.</p>
--	--

WIRING

The P-500 Flash Point Analyzer's power and customer connections are made in the Customer Connections enclosure located near the top left of the mounting rack. See Figure 3.3.

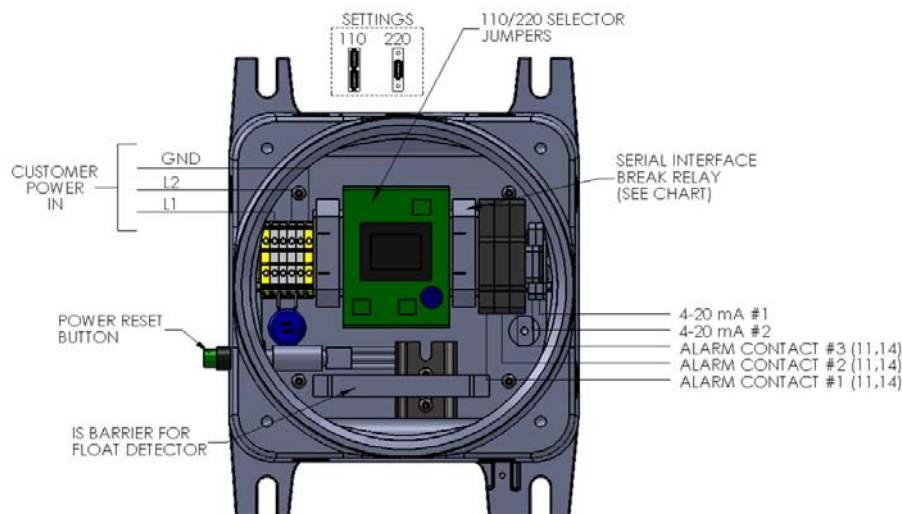





Figure 3-3: Customer Connections Enclosure

	<p>WARNING: Conduit Seals, if used, must be suitably rated a minimum of Ex d IIB + H2 for a minimum ambient of 70°C and carry a valid ATEX Certificate to EN60079-1:07.</p> <p>Cable Glands, if used, must be suitably rated a minimum of Ex d IIB + H2 for a minimum ambient of 80°C and carry a valid ATEX Certificate to EN60079-1:07.</p>
---	---

ELECTRICAL POWER

	<p>WARNING: This Analyzer is designed to meet the requirements of either the National Electrical Code (NEC) for installation in Class I, Division 1, Group C and D or European ATEX Zone 1, Group II B + H2 T4 hazardous areas. It is the user's responsibility to complete the electrical connections and comply with all pertinent codes.</p>
---	--

	<p>WARNING: All electrical connections should be made by a licensed, qualified electrician. Proper building codes and safety regulations should be followed. Only cable glands and/or conduit fittings rated for use in the area of installation should be used.</p>
---	---

The P-500 Flash Point Analyzer requires an independent 100-240 VAC, 50/60 Hz, 15A power supply. The AC power connections are made in the Customer Connections enclosure (Figure 3-3).

The P-500 Flash Point Analyzer has internal and external grounding harnesses that tie all enclosures and power distribution contained within together to a grounding lug mounted to the analyzer frame leg. The grounding wire is 10 gauge with a green/yellow spiral Teflon insulation and a 36 x 26 strand. Customer earth connection is made at this point (Figure 3-4).

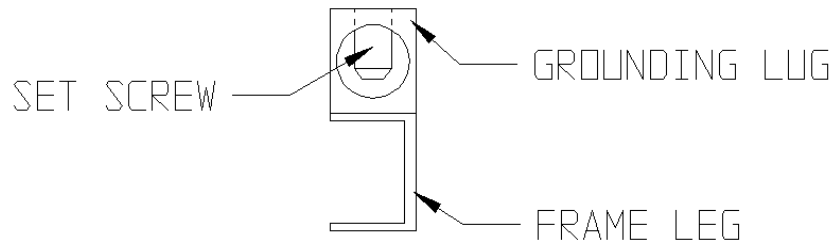



FIGURE 3-4: CUSTOMER EARTH CONNECTION

	<p>WARNING: A 360° terminated shielded cable and grounding cable glands must be used for AC power connections on instruments in ATEX Zone 1, Group II B + H2 T4 hazardous areas.</p> <p>A Fair-Rite clamp (supplied with Analyzer) with 1 turn (2 passes) must be installed on the incoming AC lines (including ground). It should be located as close as possible to the point of entry.</p>
---	---



CONTROL ROOM SIGNALS

The Analyzer incorporates analog, serial, and relay output capability. ModBus over IP output may be provided as a factory installed option.

The connections for these control room signals are made through the Customer Connection #1 port on the bottom of the Customer Connections enclosure (see Figure 3-3).

Analog Output

One isolated 4-20 mA output is standard on the P-500 Flash Point Analyzer. An optional second 4-20 mA output may be provided. See Figure 3-3.

Relay Output

The Analyzer incorporates three SPDT relay contacts rated at 3A resistive load at 250 VAC. The relays may be programmed for either normal (non-energized) or failsafe (energized) operation and used to signal a variety of operational conditions. See Section 4 for information on alarm programming.

Serial Output

[The P-500 Flash Point Analyzer incorporates RS232 serial output. The maximum allowable external cable length on the RS232 output is 98 feet (30 meters). RS485 serial output is available as an option and requires an auxiliary communications module (consult factory).

Serial communication operates at 19,200 baud, no parity, 8 start bits, 1 stop bit. Data is comma delimited; a <CR> is used to designate the end of the data stream. Data are output in the following sequence:

RS232R

Date (mm/dd/yy)
Time (hr/min/sec)
Flash point value (XX.XX°)

RS232D

Date (mm/dd/yy)
Time (hr/min/sec)
Sample Temperature (XXX°)
State
Flash point value (XX.XX°)

ModBus over IP

ModBus is available as a factory-installed option which utilizes the Analyzer's serial output. Consult ORB Instruments for more information.

Dry Contacts

The Analyzer incorporates four sets of 24 volt dry contacts that allow the control room to remotely activate selected functions. The connections for these digital inputs are made inside the Electronics enclosure (see Figure 3-5). Wiring is brought into the enclosure through the Customer Connection #2 and #3 ports on the right hand side of the enclosure.

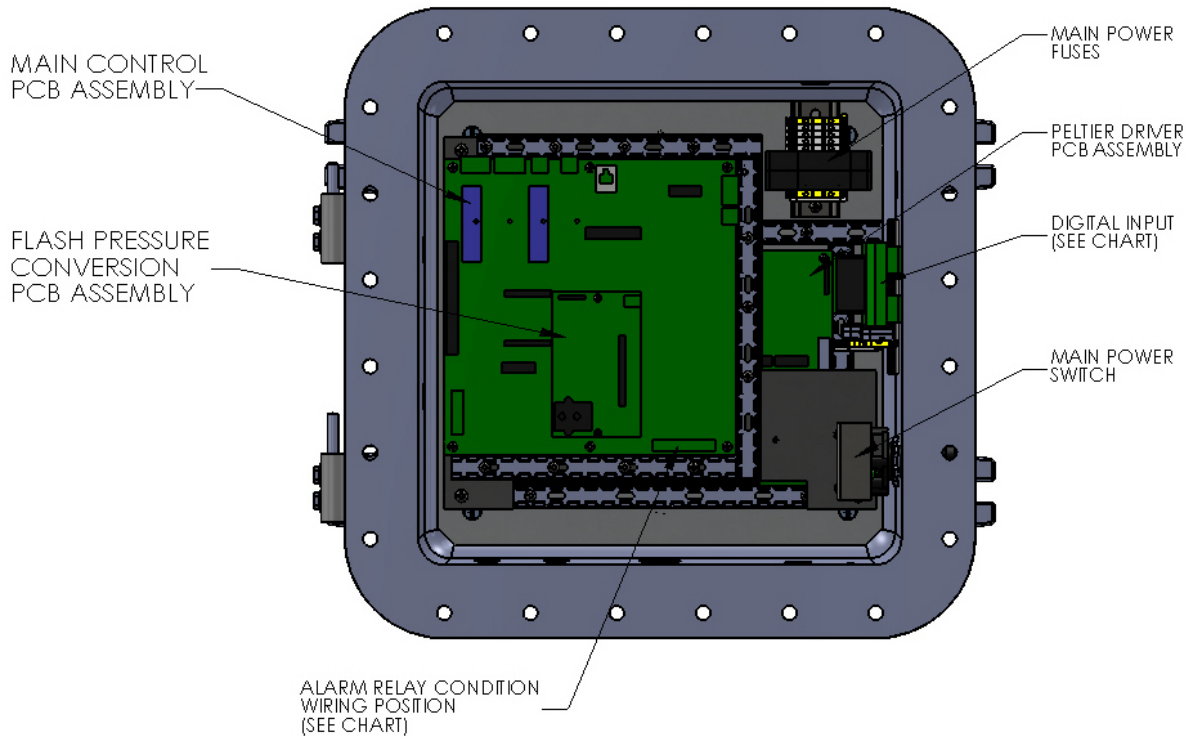

Figure 3-5: Measurement Enclosure - Dry Contacts

Customer Alarm — This connection is used to activate one or more of the Analyzer’s alarm relays when an external dry contact alarm signal is received.

Remote Standby — This connection is used to place the Analyzer in a standby mode whenever an external dry contact signal is received. Analysis will stop until the signal is removed.

Digital Input	Terminals	Function
D0	1-2	Customer alarm
D1	3-4	Remote standby
D2	5-6	Reserved for future use
D3	7-8	Reserved for future use
D4-7	9-16	Reserved for future use

STARTUP

1. With power removed from the Analyzer, start flow of sample to the Analyzer and verify that it is regulated at a pressure between 1.4 to 10.0 bar (20 and 150 PSI) and at a flow rate of 10 to 50 cc/minute.
2. Check for sample leaks at all sample line connections, the atmospheric drain connection, and within the measurement enclosure itself.
3. Start the flow of instrument air to the Analyzer and verify that it is regulated at flow of 100 to 500 cc/minute.
4. Install lid to Customer Connection box enclosure and install door bolts on both the Control and Measurement enclosures, ensuring a minimum bolt yield of stress of 240 N/mm² (34,809 pounds/inch²).
5. Apply power to the Analyzer.



NOTE: Upon initial application of external power to the Analyzer, only the Customer Connections enclosure is energized. Power will not be routed to other system components until the Power Reset button on the left side of the Customer Connections enclosure is pressed. The Power Reset button must be pressed to re-initialize the Analyzer whenever power is lost due to either an external event or internal power disruption (such as the detection of a leak within the measurement enclosure)

6. Press the Power Reset on the left side of the Customer Connections enclosure.
7. Place the Power Switch on the right side of the electronics enclosure (Figure 3-2) in the 'on' position.
8. The Analyzer's LCD should light. After a short initialization routine runs, the instrument's main "Run" screen will appear on the display. The unit should power up in the Off-Line mode.
9. You may now begin flash point analysis using the Analyzer's factory default settings or customize its performance (see Section 4).

BOX HEATER ADJUSTMENT

A manual thermostat and heater have been incorporated in the Measurement enclosure (Figure 3-6) to improve performance when analyzing samples with higher viscosities or flash point temperatures. This thermostat should be set 5° to 10° below the expected flash point temperature.

A clockwise rotation increases cabinet temperature; a counterclockwise rotation decreases cabinet temperature.

Consult ORB Instruments for additional information.

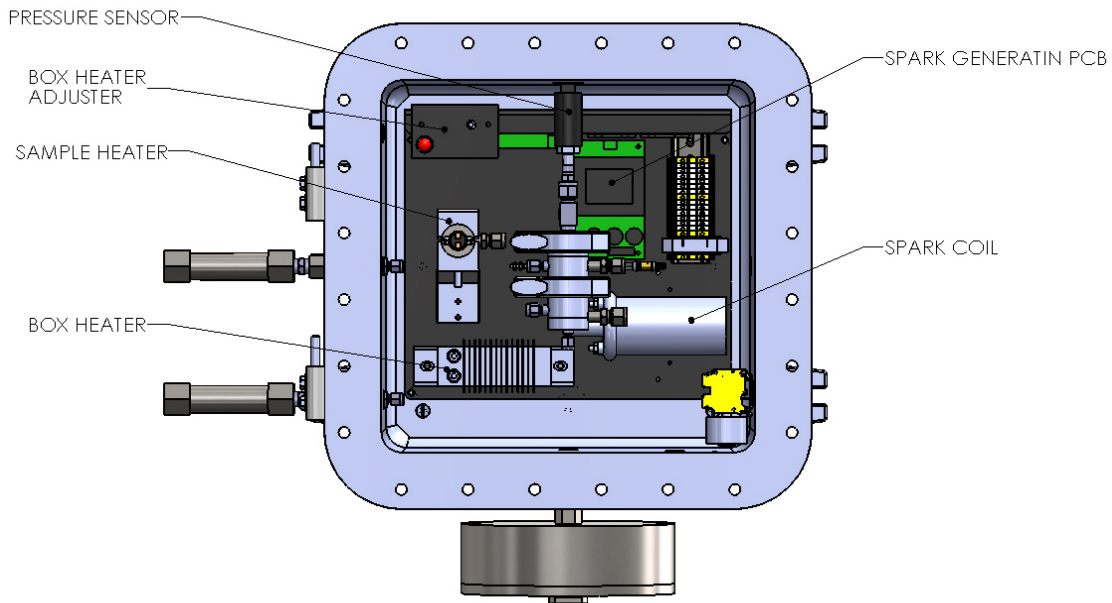



Figure 3-6: Measurement Enclosure

BASIC OPERATION

The ORB Instruments, Inc. Model P-500 Flash Point analyzer is an on-line instrument that, once started, requires little user intervention for normal operation. For information on system Programming and more advanced Operation, see Sections 4 and 5.

	<p>WARNING: The Analyzer should never be operated with the enclosures open unless deemed appropriate by proper safety authorities and with proper hot work permits</p>
---	---

MAIN RUN SCREEN

When the P-500 Flash Point Analyzer is powered up, a short initialization program runs and either the Main Run Screen or Main Menu will appear. The Main Run Screen appears if the unit is programmed to power up in On-Line mode; the Main Menu appears if the unit is programmed to power up in the Off-Line mode. By default, the Analyzer is programmed to power up in the Off-Line mode, but it can be customer programmed to power up in the On-Line mode. See the Systems Setting section below for more information.

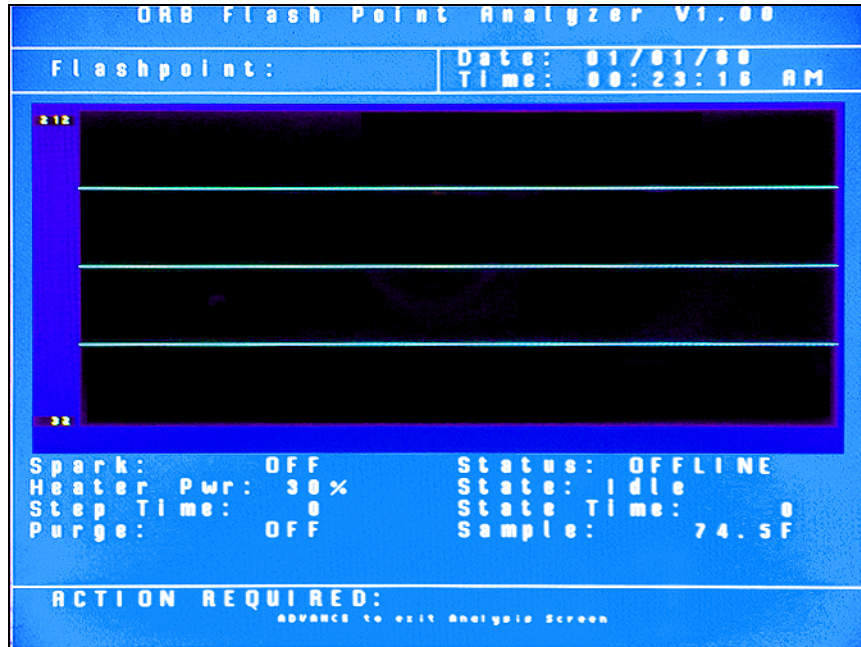

MENU NAVIGATION

The P-500 Flash Point Analyzer is programmed and controlled via a magnetic keypad on the front of the Electronics Enclosure. This eliminates the need for opening the enclosure to change operational settings, etc. A magnetic pencil is supplied with the instrument for this purpose.

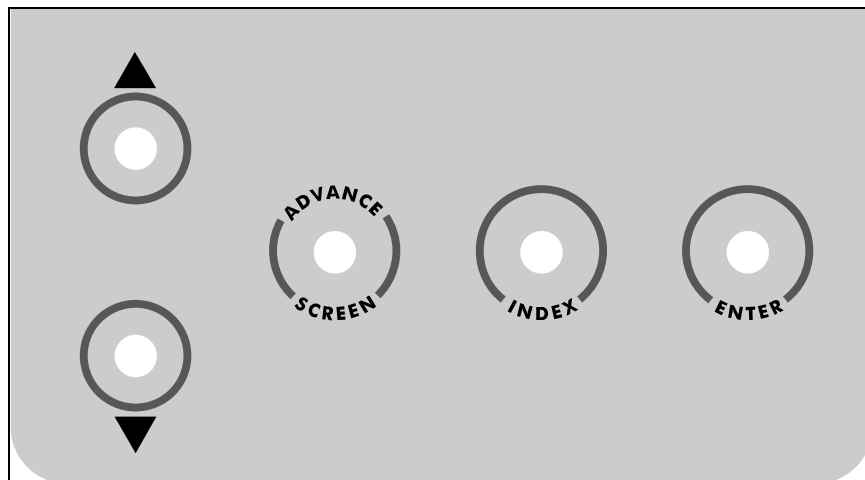

To enter or exit the analysis mode, move to a new menu or within menu items, change a displayed value, the operator simply touches a magnet to the designated location on the keypad. These locations function as follows:

Advance Screen Key — When the Main Run screen displayed, touching this key brings up the Main Menu. When any other screen is displayed, touching this key returns the display to the previous screen.

Index Key — Touching this key scrolls the Analyzer through the various items available within a specific menu. The “active” menu line is highlighted by reversing the background and foreground colors. Once you reach the last menu item, the indicator returns to the top of the menu.

Enter Key — Touching this key advances you to a sub-menu or runs a command associated with a selected menu item. It is also used to confirm some messages.

↑↓ **(Up/Down Arrow) Keys** — Touching these keys changes the displayed value for the indicated item. Depending on the specific item, it will either change the status of the selection, cycle through a list of available selections, or increase/decrease the value.

MAIN MENU

This menu is used to place the Analyzer On-Line and Off-Line. It also provides access to the all the various sub-menus. To access the Main Run screen, touch the Advance Screen key. From the Main Run screen, touch Advance Screen again to return to the Main Menu. Touch the Index key to advance to the next menu selection.

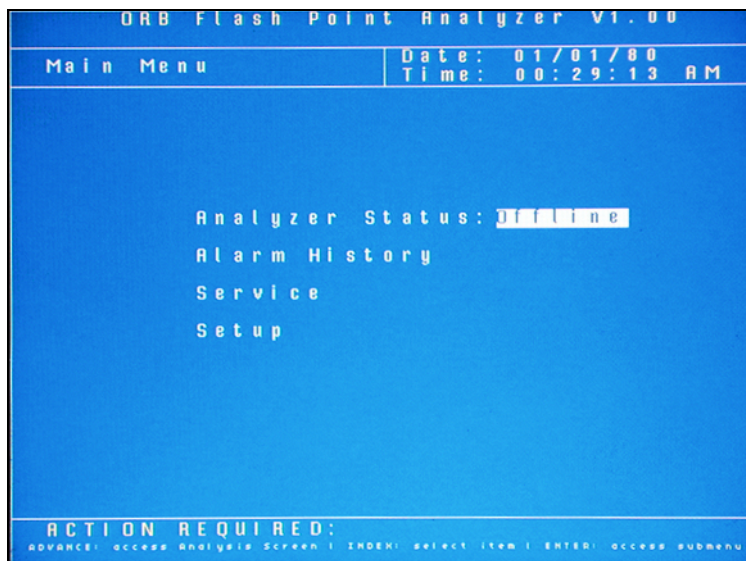

ANALYZER STATUS

This indicates the current status of the Analyzer. Touch the up/down arrow keys to change the status.

ALARM HISTORY

This menu item provides access to the Alarm History sub-menu, which lists conditions which have activated one or more of the Analyzer's alarm functions. It is described in further detail in Section 5 – Normal Operation. Touch the Enter key to access this sub-menu.

SERVICE

This menu item provides access to the Service sub-menu; entering it automatically takes the Analyzer off-line. The Service menu allows you to activate various measurement system components, test the analog output, and view selected sensor readings. It is described in detail in Section 6 – Routine Maintenance &



Service. Touch the Enter key to access this sub-menu. A screen will appear asking if you are sure you wish to enter the Service menu; this is intended to prevent you from inadvertently taking the Analyzer off-line.

SETUP

This menu provides access to the Analyzer's Setup sub-menu. This sub-menu is used to establish the instrument's output values and other operational settings. It is accessed from the Main Menu by touching the Enter key when this menu item is highlighted.

To return to the Main Run screen, touch the Advance Screen key.

SETUP SUB-MENU

The Setup sub-menu is used to establish the Analyzer's various operating parameters.

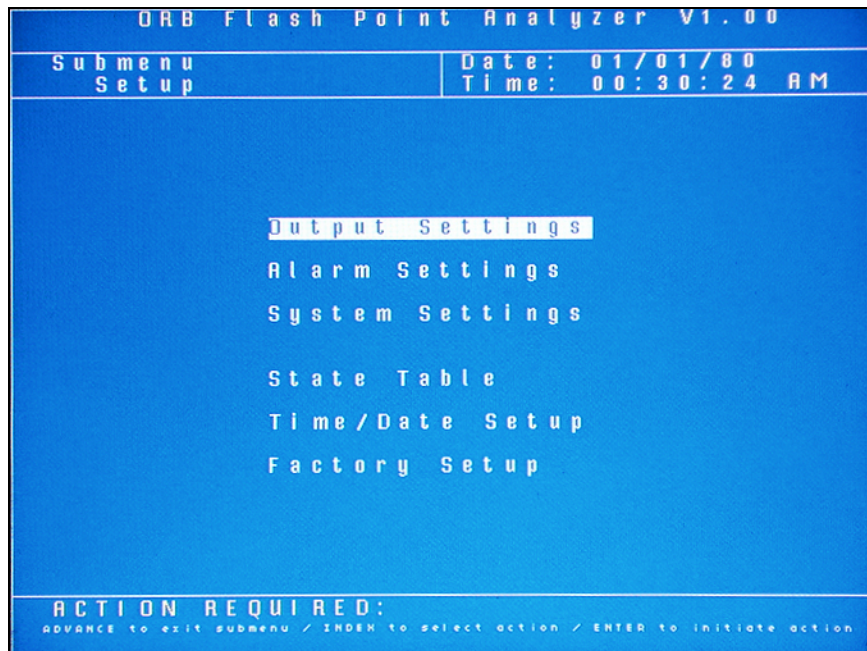

Use the Index key to advance to the desired (highlighted) menu selection. Touch the Enter key to access the selected sub-menu.

OUTPUT SETTINGS

This menu item is used to program the Analyzer's analog output, digital output, and alarm parameters. It is also used to establish how measurement information will be displayed on the Main Run screen.

```

ORB Flash Point Analyzer V1.00
-----
Sub menu      Date: 01/01/00
Output Menu   Time: 00:30:31 AM

4 - 20 mA Out 1
Output: Sample Temp   Flash Point Graph
4 mA: 32.0F           ENABLE
20 mA: 212.0F        Low: 32F
Offset: 0.0F         High: 212F
                    Clear Graph

4 - 20 Out 2
Output: Flash Point   Sample Temp Graph
4 mA: 32.0F           DISABLE
20 mA: 212.0F        Low: 32F
Offset: 0.0F         High: 212F
                    Clear Graph

Digital Output
RS - 232D

ACTION REQUIRED:
ADVANCE to exit sub menu / INDEX to change stream selection
  
```

Use the Index key to advance to the desired menu item then use the Up/Down Arrow keys to change the displayed setting or value.

4-20 Out 1 / 4-20 Out 2 — The P-500 Flash Point Analyzer's analog outputs (one standard; second optional) can be programmed to output various types of information, as well as the range of the analog signal and an offset.

Output — This menu item allows you to select the type of information that will be output using the selected analog signal. The choices are Flash Point, Sample Temperature, and Disable.

4 mA — This menu item is used to set the value at which a 4 mA signal will be output.

20 mA — This menu item is used to set the value at which a 20 mA signal will be output.

Offset — This menu selection allows you to offset the analog output signal by the programmed value. For example, if the offset is set to +1.5, the Analyzer will generate an analog signal corresponding to 61.5 when the actual measured (and displayed) concentration value is 60.0.

Digital Output — This menu item allows you to select the type of digital signal the Analyzer will output. The modes are:

RS232R — Outputs the most recent measurement.

RS232D — Outputs current status every second.

None — Digital output disabled.

Modbus Over IP — This optional digital output continuously broadcasts all pertinent data; consult ORB Instruments for more information.

	<p>NOTE: Although the Modbus selection may be present, it is only available on Analyzer's which incorporate this option.</p>
---	---

Flash Point Graph — These menu items allow you to enable/disable the flash point measurement results information that is displayed on the Main Run screen.

Enable / Disable — This menu item allows you to turn the graph on or off.

Low — This sets the lowest value on the trend graph for the measurement.

High — This sets the highest value on the trend graph for the measurement.

Clear Graph — This menu selection allows you to clear the measurement data from the Main Run screen.

Sample Temperature Graph — These menu items allow you to enable/disable the sample temperature information that is displayed on the Main Run screen.

Enable / Disable — This menu item allows you to turn the graph on or off.

Low — This sets the lowest value on the trend graph for the sample temperature.

High — This sets the highest value on the trend graph for the sample temperature.

Clear Graph — This menu selection allows you to clear the sample temperature data from the Main Run screen.

ALARM SETTINGS

This menu item is used to program the Analyzer's alarm output. The instrument incorporates dual level alarms; these alarms are activated when the measured concentration exceeds the indicated alarm value. You may set Individual flash point and sample temperature alarm values.



Use the Index key to advance to the desired menu item. Use the Up/Down Arrow keys to change the displayed setting or value. The unit of measure used for these values is set in the Other Settings menu.

Flash Point Alarms — These menu items allow you to establish alarm levels for flash point results.

Low — This sets the low alarm level. Flash point measurements below this value generate a warning alarm signal/message.

High — This sets the high alarm level. Flash point measurements above this value generate a warning alarm signal/message.

Sample Temperature Alarms — These menu items allow you to establish alarm levels for sample temperature.

Low — This sets the low alarm level. Sample temperatures below this value generate a warning alarm signal/message.

High — This sets the high alarm level. Sample temperatures above this value generate a warning alarm signal/message.

	<p>NOTE: The Analyzer DOES NOT automatically adjust alarm values when the units of measure are changed. It is the user's responsibility to make changes to these values.</p>
---	---

System Settings

The System Settings sub-menu allows you to establish global operating parameters for the Analyzer.

```

ORB Flash Point Analyzer V1.00
-----
Submenu      Date: 01/01/80
System Settings  Time: 00:30:50 AM

System Settings      Detect Control
Temp Units:           Frequency: 60 Hz
Standby Mode: ON     Spark On: 1.0 Sec
Num Cycles: 0        Spark Off: 1.0 Sec
Cycle Limit: 50000   Delta Tmp: 15 F
Come Read: 10sec     Detect Level: 500
Reload Defaults      Samp. Heat Control
Digital Inputs       Init Heat: 0 %
Cust. Alarm: DISABLE Heat Step: 5 %
Rem. Stdby: DISABLE Inc. Heat: 10sec
Screen Settings     Dec. Heat: 5 sec
Intensity: 100 %    Cool Mode: Htr Off
ScreenSaver: 15 min

Relay Type Sense
R1 Alarm Warning Fail Safe
R2 Alarm Critical Fail Safe
R3 Come Read Fail Safe

ACTION REQUIRED:
ADVANCE TO EXIT SUBMENU / INDEX TO CHANGE STREAM SELECTION
  
```

Use the Index key to advance to the desired menu item and then select it by touching the Enter key. Use the Up/Down Arrow keys to change the displayed setting or value. Touch Enter a second time to accept the displayed setting/value.

System Settings

Temperature Unit — This menu selection allows you to select the temperature scale. The choices are °C or °F.

Standby Mode — This menu item allows you to select how the Analyzer will operate upon application of power. When OFF is selected, the instrument will begin performing analyses automatically when power is applied. When ON is selected, the instrument will power up in the Off-Line mode and must be manually placed On-Line.



IMPORTANT: The Power Reset button on the side of the Customer Connections enclosure must be pressed to re-initialize the Analyzer whenever power is disrupted, even if Standby is set to Off.

Number Cycles — This is the number of measurements which have been performed since the cycle counter was last reset. To reset the counter, touch the Enter key

Cycle Limit — This menu item allows the operator to set the number measurements which can be performed before the Analyzer's Maintenance Alarm is activated. Use the Up/Down Arrow keys to change the displayed value.

Come Read — This menu item allows you to set the length of time the Analyzer's "come read" relay will be activated upon the completion of a measurement cycle.

Reload Defaults — This menu item is used to restore the Analyzer's factory default settings. When accessed by touching the Enter key, the following message appears: "Are you sure? UP = Yes, DOWN = No" Touch the appropriate Arrow key to make your selection. After the process is complete, a message will appear. Press the Enter key to continue.



NOTE: When the Analyzer's factory default settings are restored, all user programming is lost. All operational parameters will have to be re-entered.

Digital Inputs

Customer Alarm — This menu items allow you to enable and disable the Analyzer's customer-controlled digital inputs.

Remote Standby — This menu item allows you to enable and disable the Analyzer's remote standby function.

Screen Settings — These menu items allow you to adjust Analyzer's LCD.

Intensity — This is a brightness adjustment.

Screen Saver — This establishes how long the screen will remain lit without any keypad activity. Touching any of the magnetic keys re-activates the display. A value of zero disables the screen saver.

Detect Control — These menu items allow you to change the Analyzer's spark control settings.

Frequency — This is the electrical frequency used during spark generation. It may be set at 50, 60, 100, or 120 Hz.

Spark On — This sets the 'on' portion of the spark duty cycle during flash point detection.

Spark Off — This sets the 'off' portion of the spark duty cycle during flash point detection.

Delta Temperature — This sets the starting point (in degrees) for spark initiation. The displayed value is the number of degrees below the last detected flash point temperature at which spark initiation will begin.

Detect Level — This is a pressure sensitivity setting that establishes the threshold that must be exceeded to signal flash point detection. In general, lower values should be used when measuring the flash point of lighter samples and high values used when measuring the flash point of heavier samples.

Sample Heat Control — These menu items allow you to change the Analyzer's sample heater control settings.

Initial Heat — This is the percentage of total power that will be applied to the sample heater.

Heat Step — This sets how much heater power will be increased each time the programmed period of time elapses (Incremental Heat) without flash detection.

Incremental Heat — This sets the time parameter for increasing heater power. Each time the programmed period of time elapses during the heating cycle, heater power will be increased by the percentage established in the Heat Step.

Decremental Heat — This sets the time parameter for decreasing heater power. Each time the programmed period of time elapses during the cooling cycle, heater power is decreased 1%.

Cool Mode — This sets the overall parameter for cooling. When set to 'Off', the sample heater is completely off during cooling. When set to 'Decrement', power to the heater is gradually decreased using the parameter programmed under Decremental Heat.

Relay — These menu items allow you to enable/disable the alarm relays, indicate the type of alarm it will signal, and how the relay will operate.

Relay — This designates which alarm is being programmed. See Section 3 for alarm relay wiring information.

Type — This designates the type of alarm.

Off — Alarm relay disabled.

Warning Critical — Measured concentration has exceeded either the low or high alarm setpoint. Warning alarms do not disrupt analysis.

Warning Alarm — This type of alarm indicates Analysis has stopped because one of the following conditions has been detected:

- Measurement system failure
- Customer alarm
- Remote standby enabled
- Machine not running

Maintenance — Activated when the number of measurement cycles has exceeded the 'Cycle Limit' setting.

Come Read — Activated for a programmed period of time upon the completion of a measurement cycle.

Sense — This designates whether the alarm relay will energize or de-energize when an alarm condition is detected. When Normal is selected, power will be applied to the relay when an alarm condition is detected; when Failsafe is selected, power will be removed from the relay when an alarm condition is detected.

TIME/DATE SETUP

The Time/Date Setting sub-menu is used to set the Analyzer's internal calendar and clock.

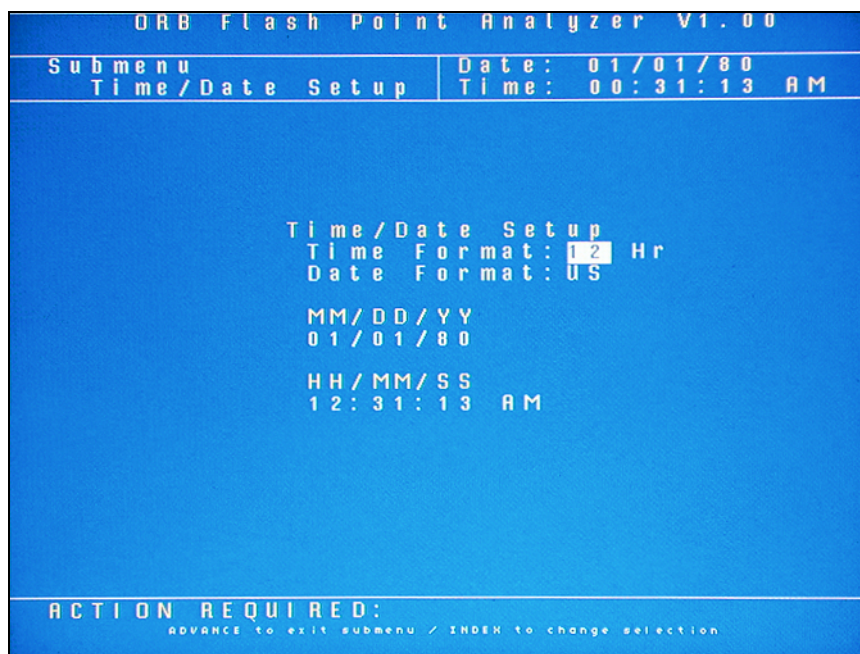

Time Format — This menu item allows you to select either a 12 or 24 hour time format. Touch the Up/Down Arrow keys to change the displayed value.

Date Format — This menu item allows you to select the format in which the date will be displayed. The selections are US (month/day/year) or EU (day/month/year). Touch the Up/Down Arrow keys to change the displayed value.

Date — This menu item allows you to program the Analyzer with the current date. To change the displayed date, touch the Enter key and then use the Index key to advance the cursor to the field which needs to change. Use the Up/Down Arrow Keys to change the value in the selected field. Touch the Enter key a second time to accept the new date entry.

Time — This menu item allows you to program the Analyzer with the current time. To change the displayed time, touch the Enter key and then use the Index key to advance the cursor to the field (Hour/Minute/Second) which needs to change. Use the Up/Down Arrow Keys to change the value in the selected field. Touch the Enter key a second time to accept the new date entry.

STATE TABLE

The State Table setup selection allows you to modify, add, or delete steps in the measurement process.

	<p>NOTE: Any changes made will affect how the Analyzer performs a measurement. You should have a complete and thorough understanding of how the instrument performs measurements before making any changes to the State Table.</p>
---	---

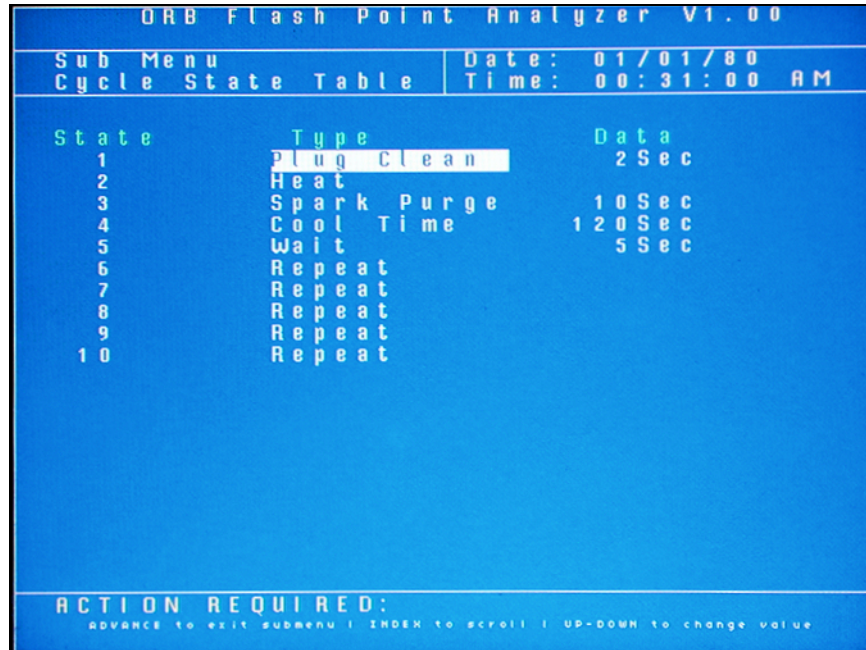

State	Type	Data
1	Plug Clean	2 Sec
2	Heat	
3	Spark Purge	10 Sec
4	Cool Time	120 Sec
5	Wait	5 Sec
6	Repeat	
7	Repeat	
8	Repeat	
9	Repeat	
10	Repeat	

ACTION REQUIRED:
ADVANCE to exit submenu | INDEX to scroll | UP-DOWN to change value

Any of the following steps may be included in a flash point measurement cycle. Steps highlighted in **bold face** type are required. The last step in any measurement cycle must be **Repeat**.

Heat — This is the main measurement step and sets the sensitivity of the pressure transducer used to detect flash point. The higher the value, the greater the required pressure change for flash detection.

Cool Temp — This is the number of degrees to cool the cell after flash point is detected. The value is the programmed value below the last detected flash point temperature. For example, if flash was detected at 75°C and the programmed value is 10, the cell will be cooled to 65°C. This step must be included in a measurement cycle unless Cool Time (below) is selected.

Cool Time — This is the amount of time to cool the measurement cell after flash point is detected. It is programmed in seconds. This step must be included in a measurement cycle unless Cool Temp (above) is selected.

Spark Purge — This step is used to help cool and clean the spark when the optional spark purge solenoid is installed. The programmed value is the amount of time (in seconds) that the solenoid will be open and air blown across the spark electrode after flash point is detected.

Plug Clean — This step is used to burn residue off the spark electrode. The programmed value is the amount of time (in seconds) that spark will be applied after flash point is detected.

Wait — This step idles the Analyzer for the specified amount of time (in seconds). It is generally used as a stabilization step.

Repeat — This should always be the last step in the State table. It tells the Analyzer to return to step 1.

FACTORY SETUP

This is a password protected sub-menu intended for factory use only.

	<p>NOTE: Normal operation requires very little user intervention. What is recommended are occasional checks of the utility and sample supplies to ensure that they are within the range set forth in Section 2 and close to the most recent user set points. Variations in process conditions may cause system instability and possible system damage. The following visual checks should be made as frequently as practical to maintain maximum system efficiency :</p> <ul style="list-style-type: none"> • Sample supply pressure (1.4-10.0 bar / 20-150 psi) • Sample supply flow (10-50 cc/minute) • Sample supply temperature (5°-35°C / 9°-63°F below expected flash point) • Combustion air supply pressure (0.7-1.4 bar / 10-20 psi) • Instrument air supply flow (500-1000 cc/minute)
---	---

The P-500 Flash Point Analyzer is an on-line process instrument designed to measure the flash point of petroleum products.

In normal operation, these measurements and other pertinent monitoring information are displayed on the Analyzer's liquid crystal display. Measurement data are also output as analog and digital signals. Upon the application of power, the Analyzer runs a short initialization program and then displays either the Main Run screen or the Main Menu, depending on how the Standby mode has been set up (see Section 4 – Programming). If the Main Run screen is displayed upon power up, the instrument is in the on-line (analyzing) mode; if the Main Menu is displayed on power up, the instrument is in the off-line (idle) mode.

MAIN RUN SCREEN

The Analyzer's Main Run screen provides both measurement data and system operation information. A typical Main Run screen appears below:

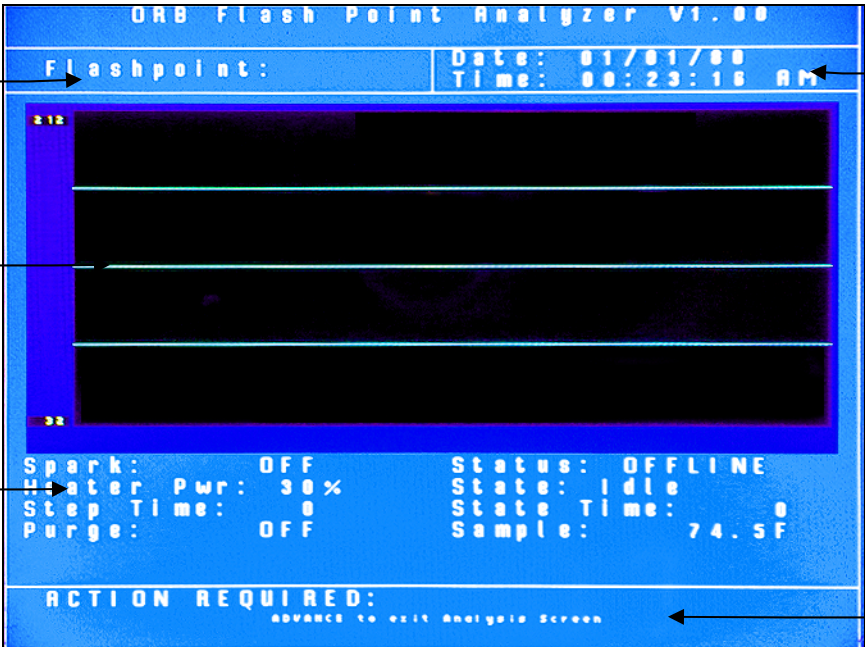

Measurement Results →

Graphical Data Display →

Operational Status →

Current Date and Time →

Message Line →

Measurement Results — The two most recent measurements. Measurement data are displayed in either degrees C or degrees F and are updated at the end of each measurement cycle.

Date & Time — The current date and time as tracked by the Analyzer's internal calendar and clock.

Graphical Data Display— Displays measurement data. If power is lost or disrupted, the displayed graph is lost. The graph can also be cleared/refreshed via the Output Settings menu.

Operational Status — Identifies the status and state of various Analyzer components and systems.

Spark — Indicates the status of the Analyzer’s spark electrode.

Heater Pwr — Indicates the percentage power being applied to the sample heater.

Step Time — Indicates the elapsed time in the heat step.

Purge — Indicates the status spark purge is enabled (ON) or disabled (OFF).

Status — Indicates if the Analyzer is online or offline.

State — Indicates the current step in the measurement cycle.

State Time — Indicates the elapsed or remaining time in the current step.

Sample — Indicates sample temperature.

Message Line — Important operational messages, such as the detection of an alarm condition, remote standby, etc. are displayed in this area.

SIGNAL OUTPUTS

4 – 20 MA ANALOG OUTPUT

The P-500 Flash Point Analyzer outputs an analog signal proportional to the last measured value. The range of the analog signal is user-programmable (see Section 4 – Programming). This signal is updated at the end of the measurement cycle.

	<p>NOTE: A second analog output is available as an option.</p>
---	---

SERIAL OUTPUT

RS232R — When this digital output is enabled, the measurement data are output by the Analyzer at the end of every measurement cycle. Data is comma delimited; a <CR> is used to designate the end of the data stream. Following is an example of the RS232R data stream:

Date (mm/dd/yy)
Time (hr/min/sec)
Flash point value (XX.XX°)

RS232D — When this digital output is enabled, the measurement data are output by the Analyzer every second. Data is comma delimited; a <CR> is used to designate the end of the data stream. Following is an example of the RS232D data stream:

Date (mm/dd/yy)
Time (hr/min/sec)
Sample Temperature (XXX°)
State
Flash point value (XX.XX°)

Modbus over IP — ModBus output is available as a factory installed option and uses the Analyzer’s serial interface. Consult ORB Instruments for additional information.

ALARMS

When an alarm condition is detected, a message will be displayed in the Message Line of the current screen. Depending on the type of alarm and the user-programming of the alarm relays, an alarm relay may also be activated.

TYPES OF ALARM CONDITIONS

Alarm Warning — A warning alarm indicates that either the measured flash point value or sample temperature is outside the acceptable programmed limits. Analysis continues.

Alarm Critical — An alarm of this type indicates that analysis has stopped.

Come Read — This signals that the Analyzer has completed a measurement cycle and that the new result has been output. Analysis continues.

Maintenance — This signals that routine maintenance is required. Analysis continues.

Informational Messages — These messages provide operational information, such as a validation is being performed, etc. Analysis continues.

When an alarm condition is detected, the appropriate alarm relay is activated (if enabled) and the alarm condition logged on the Alarms History sub-menu.

Type	Message and/or Alarm Condition	Analyzer State
Alarm Warning	Low flashpoint <i>(flashpoint temperature below programmed alarm value)</i>	Analysis continues
Alarm Warning	High flashpoint <i>(flashpoint temperature above programmed alarm value)</i>	Analysis continues
Alarm Warning	Low sample temperature <i>(sample temperature below programmed alarm value)</i>	Analysis continues
Alarm Warning	High sample temperature <i>(sample temperature above programmed alarm value)</i>	Analysis continues
Alarm Critical	Bad or open sample RTD <i>(faulty RTD)</i>	Analysis stops
Alarm Critical	Bad sample heater <i>(faulty sample heater)</i>	Analysis stops
Alarm Critical	Ext. sample heater <i>(sample temperature above 300°F)</i>	Analysis stops
Come Read	Measurement cycle complete	Analysis continues
Maintenance	Routine maintenance required	Analysis continues
Informational message	Ext. customer alarm <i>(external customer alarm signal received)</i>	Analysis continues
Informational message	Remote standby active <i>(external signal received placing Analyzer in Standby; analysis continues when signal removed)</i>	Analysis stops
Informational message	Validation requested <i>(external signal received to perform a validation)</i>	Analysis continues
Informational message	Validation in progress <i>(validation measurement being performed)</i>	Analysis continues

	<p>NOTE: An alarm relay is activated only if one is programmed for that particular alarm type. See Section 4 – Programming.</p>
---	--

ALARM HISTORY

Operational alarms are logged and may be accessed via the Alarm History sub-menu. To access this sub-menu, go to the Main Menu, select Alarm History, and touch Enter. The Alarm History screen will appear.



To clear the alarm history, touch the Enter key when Reset is highlighted.

TAKING THE ANALYZER OFF-LINE

The P-500 Flash Point Analyzer may be taken off-line either locally from the front panel of the instrument or, if wired to do so, remotely via a contact closure from the control room.

LOCALLY

To exit analysis from the instrument's front panel, first access the Main Menu by touching the Advance Screen Key with the magnetic pencil and then select Status. Touch the Up/Down Arrow keys to toggle the status to OFF. You will be asked to confirm that you wish to take the Analyzer offline.

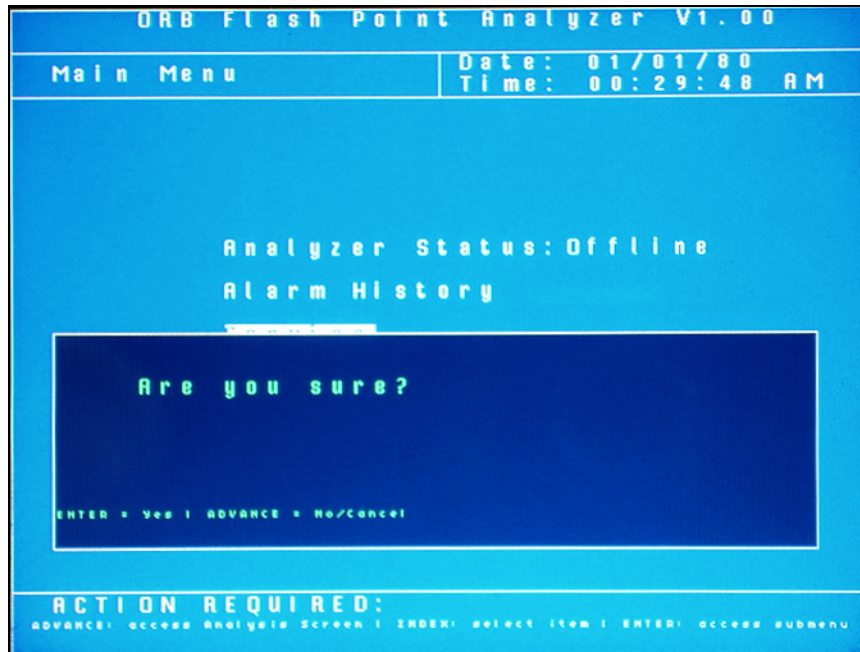

Touch the Enter Key for yes, touch the Advance Key to cancel.

REMOTELY

The Analyzer may also be taken off-line via an optional remote dry contact relay closure (see Section 3). The instrument will remain idle until the signal is removed. A message indicating that the instrument has been remotely idled is displayed on the Main Run screen.

LOSS OF POWER RESTART

In the event of a power loss, the P-500 Flash Point Analyzer will automatically begin monitoring when power is restored if the Standby mode (see Section 4) is set to OFF. If the Standby mode is set to ON, the Analyzer will have to be placed online manually by accessing the Main Menu and then setting Status to ON.

	<p>IMPORTANT: In order to restart the Analyzer after external power has been lost, the Power Reset button on the side of the Customer Connections enclosure must be pressed — regardless of the Standby setting.</p>
---	---

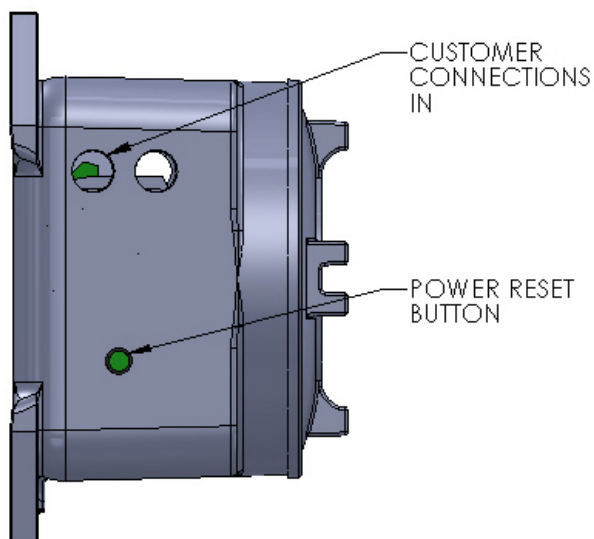

Figure 5-1: Power Reset Button

INTERNAL SAMPLE LEAK

The Analyzer incorporates a sample leak detector mounted on the bottom of the Measurement enclosure. Should an internal sample leak occur, accumulation of fluid in the bottom of the enclosure activates the leak detector and immediately removes power from the Measurement and Electronics enclosures.

To restore power once the leak has been corrected and fluid removed from the Measurement enclosure, press the Power Reset Button on the side of the Customer Connections enclosure. The Analyzer will restart.

ROUTINE MAINTENANCE & SERVICE

SECTION 6

	WARNING: Service should only be performed by qualified service personnel. Before performing any of the following procedures, disconnect unit from its electrical source. If electrical power is required, exercise extreme care as “LINE VOLTAGE” is present.
---	--

	CAUTION: Be sure to obtain all necessary permits and perform any required gas testing before opening the instrument’s enclosures.
---	--

	WARNING: To prevent injury, the Analyzer must be shut off from the process. Personnel must avoid contact with hot equipment or sample.
---	---

RECOMMENDED ROUTINE MAINTENANCE SCHEDULE

Check sample flow and pressure	Daily
Check combustion air flow and pressure	Daily
Inspect clean flash cup, spark electrode, and combustion air tube	Every 7 to 30 days
Clean spark electrode and air purge tube	Every 6 months or sooner, as required
Replace spark electrode	Every 6 months
Replace spark coil wire	Annually

TAKING THE ANALYZER DOWN FOR SERVICE

Take the Analyzer off-line via the procedure outlined in Section 5 and then remove power via the switch on the right hand side of the Control Enclosure. Remove power from the customer connection box (via external power switch or breaker panel) and lock out system supply voltage per local guidelines.

Close sample and instrument air supply valves and lock those valves closed as well.

Open instrument enclosures and allow system at least fifteen minutes to cool down from process temperatures. The system is now ready for periodic maintenance practices.

	WARNING: Never attempt to replace any consumables on the system live as the spark circuitry operates at 10,000 VDC.
---	--

SERVICE AND OPERATIONAL CHECKS

The Analyzer incorporates a special Service screen from which the operator can perform a variety of verification and diagnostic functions, including:

- Exercise the Analyzer's mechanical valves, sample heater, alarms, and digital inputs.
- Output a fixed analog signal to check/calibrate external devices

The Service screen is accessed from the Main Menu by selecting Service and touching the Enter key with the magnetic pencil.

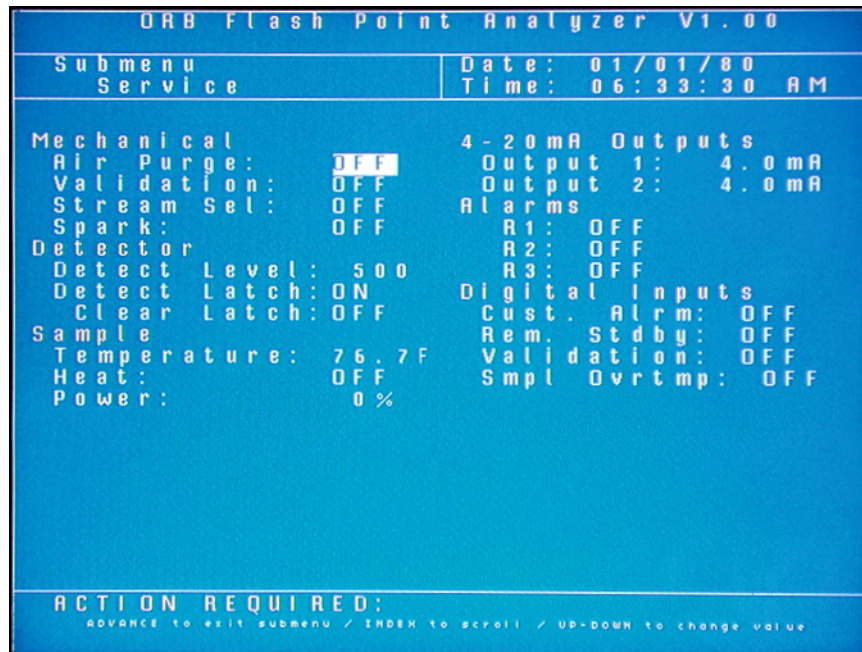

Mechanical — The operation of the Analyzer's various solenoids can be checked via these menu items. The Up/Down Arrow keys are used to change the status.

Air purge — The air purge valve is opened when this menu item is switched from OFF to ON.

Validation — The Analyzer's validation solenoid is opened when this menu item is switched from OFF to ON.

Stream Select — The Analyzer's stream switching solenoid valve is opened when this menu item is switched from OFF to ON.

Spark — A spark is generated by the Analyzer's spark electrode when this menu item is switched from OFF to ON.

Detector — These menu items are used to check the Analyzer's flash detection system. The Up/Down Arrow keys are used to change the status.

Detect Level — This displays the Analyzer's current detection level setting.

Detect Latch — This displays the status of the Analyzer's detection latch.

Clear Latch — The Analyzer's detection latch opens when this menu item is switched from ON to OFF.

Sample — These menu items are used to check the Analyzer's sample heater. The Up/Down Arrow keys are used to change the status or values.

Temperature — This displays the sample temperature.

Heat — This tests the operation of the flash cup heater. The sample temperature should rise as heat is applied to the flash cup.

Power — This setting determines the amount of power (in percent) that will be applied to the flash cup heater.

4-20 Outputs — This menu item allows you to output an analog signal with which to calibrate external devices. The Up/Down Arrow keys are used to increase/decrease the analog signal value.

4-20 mA Out 1 — When this menu item is selected, a continuous analog signal equivalent to the displayed value is generated on the Analyzer's primary 4-20 mA output channel.

4-20 mA Out 2 — This menu selection is only active if the Analyzer is equipped with the optional second analog output. When it is selected, a continuous analog signal equivalent to the displayed value is generated on the Analyzer's optional 4-20 mA output channel.

Alarms — These menu selections allow you to test the operation of the Analyzer's alarm relays.

Digital Inputs — These menu selections allow you to test the operation of the Analyzer's digital inputs.

TROUBLESHOOTING

Symptom	Possible Cause	Solution
Flash point not detected	No spark	Dirty or faulty spark electrode; clean or replace as required. Faulty spark coil wire; check and replace as required. Faulty spark coil; replace as required.
	Sample not being heated	Faulty heater; check heater operation and replace as required.
	No sample	Check for proper sample flow and pressure.
	No combustion air	Check for proper combustion air flow and pressure.
	Faulty pressure sensor	Check and replace as required.
Inaccurate flash point measurements	Detect level set too high or too low	Check and adjust as required.
	Flow of combustion air too low	Check and adjust as required.
	Faulty RTD	Replace as required.
	Sample temperature too high	Consult factory.
	Faulty pressure sensor	Check and replace as required.
Display screen not working	Screen saver on Electronics problem	Touch magnetic pencil to keypad. Consult factory.
Keypad not working	Electronics problem	Consult factory.

COMPONENT CLEANING & REPLACEMENT

FLASH CUP

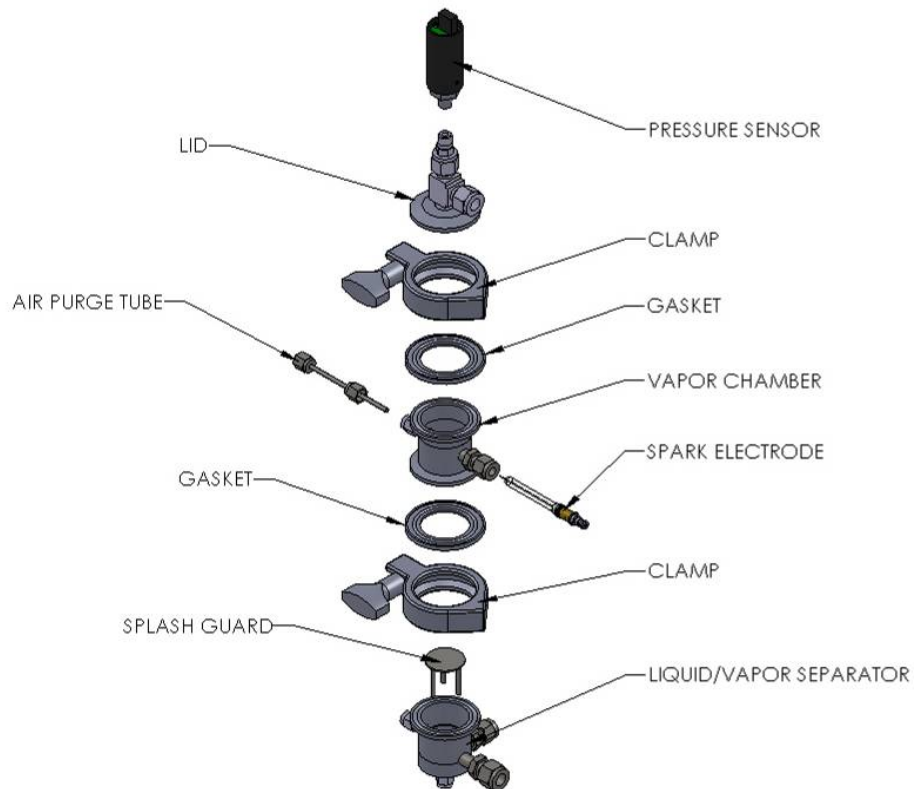

Figure 6-1: Flash Cup & Components

The flash cup should be opened and inspected on a regular basis and cleaned as required. A suitable solvent and stiff bristled brush should be used to remove coking, etc. from all interior surfaces.

AIR PURGE TUBE

The air purge tube should be inspected on a regular basis and cleaned as required.

1. Remove the air purge tube from the flash cup.
2. Wipe with a suitable solvent to remove as much coke, etc. as possible. Polish tip with an emery cloth, if necessary.
3. Re-installed air purge tube in flash cup.

SPARK ELECTRODE

The spark electrode should be inspected on a regular basis and cleaned/replaced as required.

1. Remove spark electrode from flash cup.
2. Wipe with a suitable solvent to remove as much coke, etc. as possible. Replace electrode if damaged or worn.
3. Re-install spark electrode in flash cup.

ASSEMBLY DRAWINGS

FLASH CUP

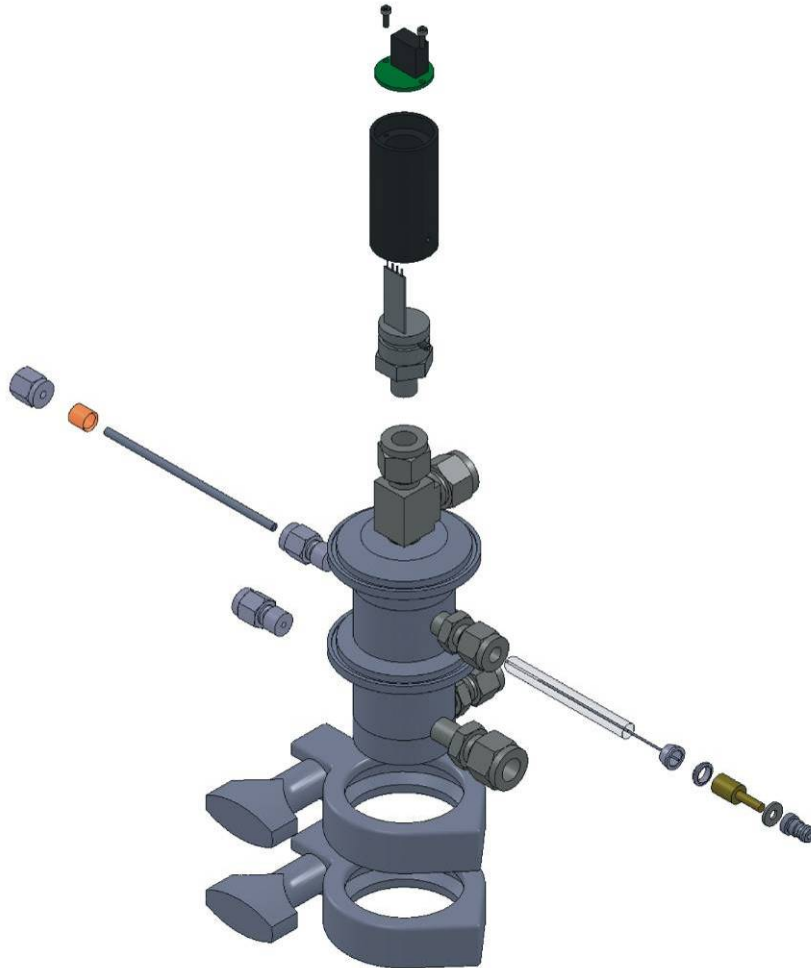

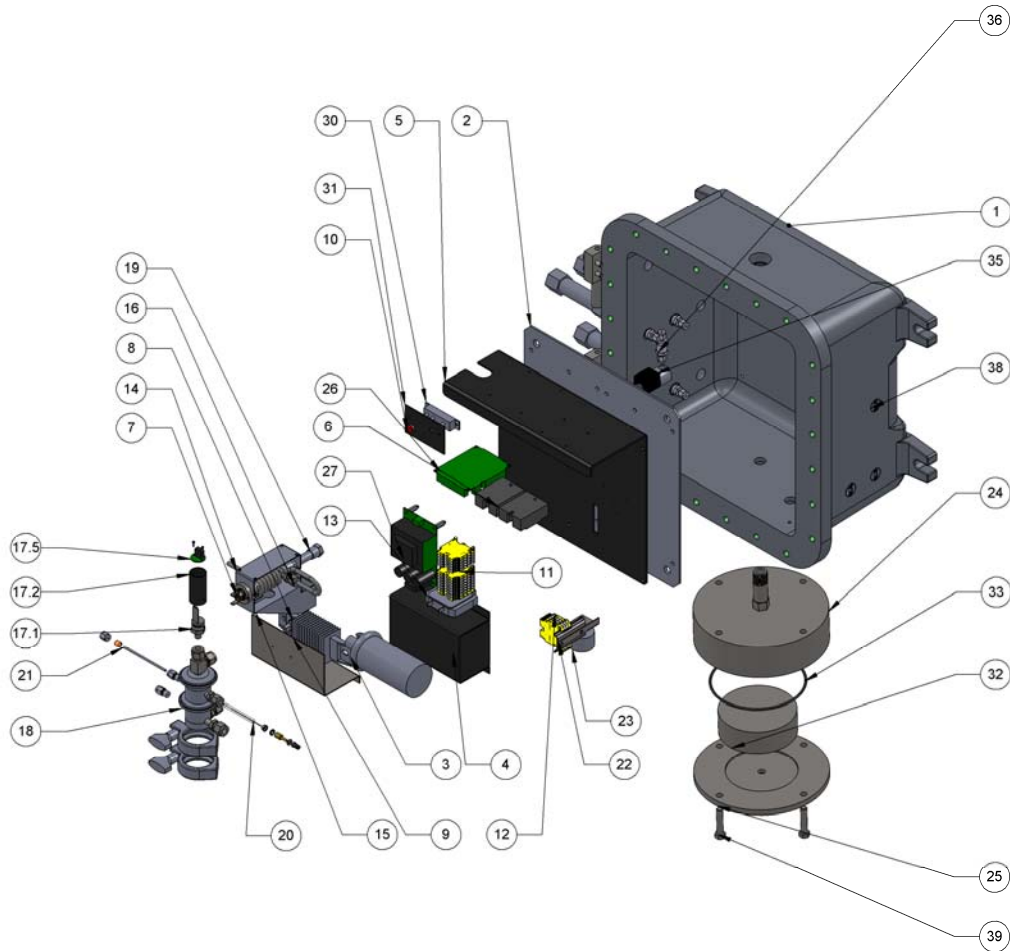

ITEM NO.	PART NUMBER	DESCRIPTION	QTY.
1	680009	RVP/VL 20 EXPLOSION PROOF ENCLOSURE	1
2	700524	BACKPLATE	1
3	620087	FLASH POINT SPARK IGNITOR	1
4	701322	SPARK COIL COVER	1
5	701321	BACKPLATE	1
6	620111	SOLID STATE RELAY	2
7	620083	THERMO SWITCH	1
8	620164	240V HEATER	1
9	701386	HEATER COVER	1
10	620174	NEON LIGHT	1
11	620057	TERMINAL BLOCK	14
12	620056	GROUND TERMINAL BLOCK	6
13	620063	RELAY	1
14	701324	HEATER BRACKET - UPPER	1
15	701323	HEATER BRACKET - LOWER	1
16	701465	HEAT TUBE WELDMENT	1
17	701332	PRESSURE SENSOR ASSY	1
17.1	660008	FLASH POINT PRESSURE SENSOR	1
17.2	701331	PRESSURE SENSOR COVER TUBE	1
17.5	788099	FLASH POINT PRESSURE SENSOR PCB ASSY	1
18	701464	FLASH CUP ASSY	1
19	620163	CARTRIDGE HEATER	1
20	700660	SPARK ELECTRODE - DYNAMIC	1
21	700661	SPARK ELECTRODE - STATIC	1
22	701988	FLOAT BRACKET	1
23	660005	FLOAT SWITCH	1
24	670007	ARRESTOR WELDMENT	1
25	701443	ARRESTOR HOUSING, TOP	1
26	788102	TRANSFER PCB ASSY	1
27	788096	SPARK CONTROL PCB ASSY	1
29	650284	3/8 X 1/4" NPT TEE FITTING	1
30	620165	THERMOSTAT	1
31	701476	THERMOSTAT COVERPLATE	1
32	650278	DRAIN FLAME ARRESTOR	1
33	690007	FLAME ARRESTOR HOUSING O-RING	1
34	P-500 E-RAIL 5.375	RAIL	1
35	650447	SOLENOID VALVE	1
36	650190	CHECK VALVE	1
37	701300	FLAME ARRESTOR ASSY	3
38	620132	1/2" PLUG	8
39	HBQ T-3 3/50-16x1.75x1.1N		4

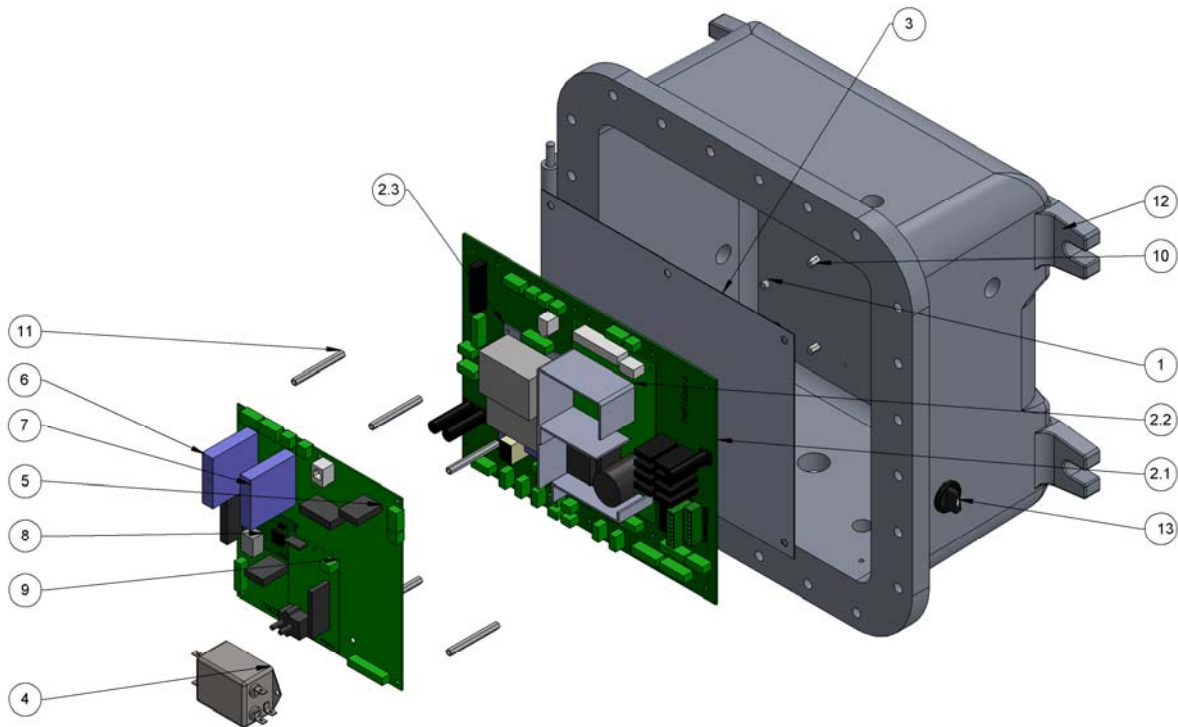

ITEM NO.	PART NUMBER	DESCRIPTION	QTY.
1	701910	MTG PLATE FOR MOTHERBOARD 798115	1
2	701937	LOWER ELECTRONICS PLATE	1
2.1	798115RA	MAIN DISTRIBUTION PCB ASSY	1
2.2	620038	POWER SUPPLY (+24 VDC)	1
2.3	620037	POWER SUPPLY (+5, +/- 12 VDC)	1
3	701911	FISH PAPER FOR MOTHERBOARD 798115	1
4	620076	LINE FILTER	1
5	700318	MAIN PCB ASSY	1
6	620081	RTD INPUT MODUKE	1
7	620080	4-20 mA OUTPUT MODULE	1
8	600025	MICROPROCESSOR CORE MODULE	1
9	700321	RVP ADAPTER PCB ASSY	1
10	4-40 x 0.4375 F-F Nylon Standoff		2
11	10-32 x 2.500 F-F Aluminum Standoff		6
12	701510	UPPER ENCLOSURE	1
13	620149	SELECTOR SWITCH	1

CONTROL ENCLOSURE DOOR

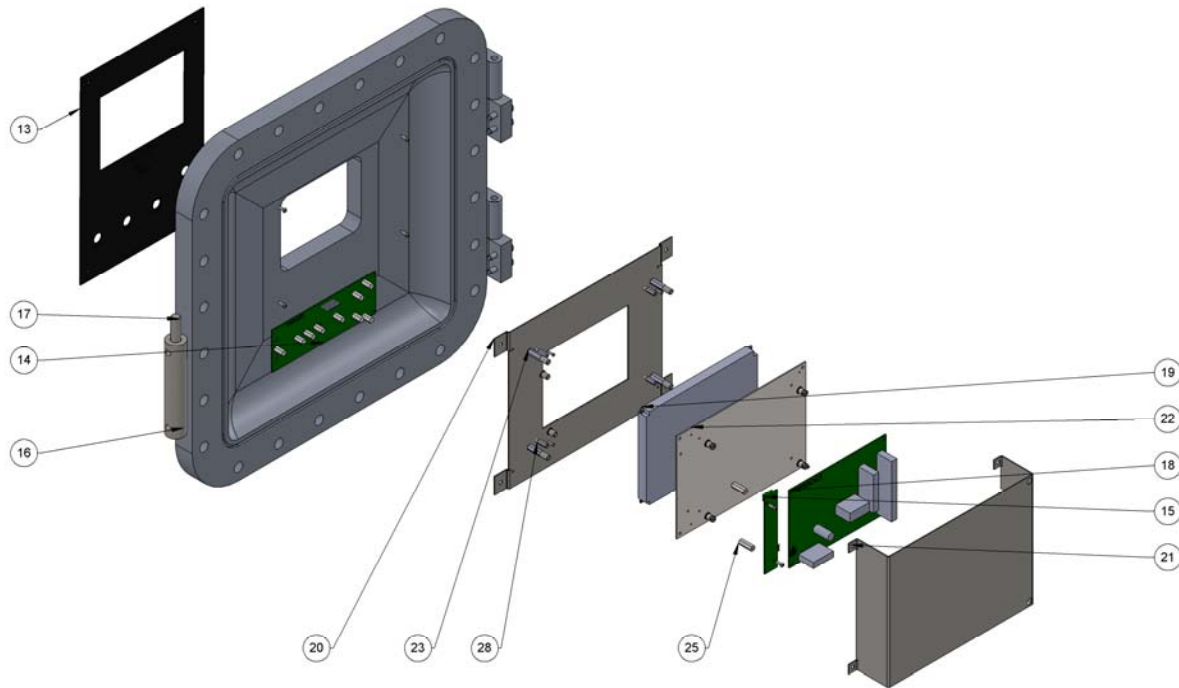

ITEM NO.	PART NUMBER	DESCRIPTION	QTY.
14	798030	MAGNETIC KEYPAD PCB ASSY	1
15	700288	BACKLIGHT DRIVER PCB	1
16	700348	EXP PROOF MAGNETIC PENCIL HOLDER	1
17	700701	MAGNETIC PENCIL ASSY	1
18	798063	DISPLAY DRIVER PCB ASSY	1
19	700286	GRAPHICS DISPLAY ASSY	1
20	700787	DISPLAY BRACKET	1
21	700793	COVER PLATE	1
22	700062	DISPLAY MOUNTING BRACKET	1
23	4-40 x 0.750 F-F Aluminum Standoff		4
25	4-40 x 0.750 F-F Nylon Standoff		2
28	2-56 x 0.500 F-F Aluminum Standoff		4



SPARE & REPLACEMENT PARTS

SECTION 7

SPARE PARTS KITS

Description	Part Number
1-YEAR PARTS KIT.....	700613
Spark electrode, 2 each.....	700660
2-YEAR PARTS KIT.....	700614
Spark cable, 1 each.....	620166
Pressure sensor assembly, 1 each	701332
Spark electrode, 4 each.....	700660

REPLACEMENT PARTS

Description	Part Number
Fuse (250 VAC, 2 A), / 230 VAC systems, 1 each.....	620035
Fuse (250 VAC, 5 A) / 115 VAC Systems, 1 each	620036
Power Supply (+5, ±12 VDC), 1 each	620037
Power Supply (+24 VDC), 1 each	620038
Spark Igniter, 1 each	620087
Cartridge Heater (120 VAC) , 1 each	620192
Cartridge Heater (240 VAC), 1 each	620163
Drain Flame Arrestor, 1 each	650278
RTD Sensor, 1 each	660001
Pressure Sensor Assembly, 1 each	701332
Graphics Display Assembly, 1 each.....	700286
Backlight Driver PCB, 1 each	700288
Cable Assembly, 1 each.....	700289
Main Control PCB, 1 each.....	700318
Spark Electrode, 1 each	700660
Spark Cable, 1 each	620166
Magnetic Keypad Assembly, 1 each	798030
TE Driver PCB, 1 each	798040
Display Controller PCB, 1 each.....	798063
Flash Cup Assembly*, 1 each	700459

* Consists of High Temperature Thermoelectric Modules, Detection Cell with High-Res Pressure Sensor, Stainless Steel Cooling Blocks, PnP Ready ORB Component Certificate, 1-Year Warranty.



03-27-2014

[THIS PAGE INTENTIONALLY BLANK]